

Note: Trim windshield
as necessary to fit

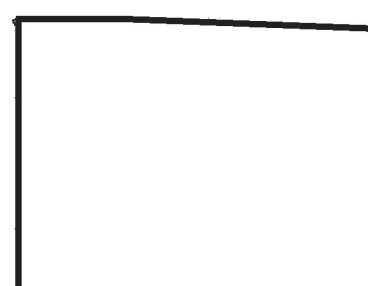

bler--bottom only

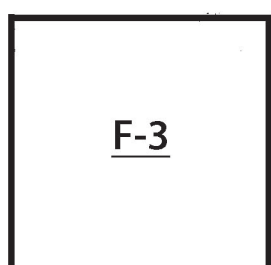

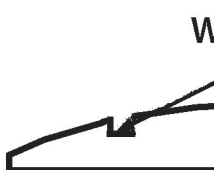
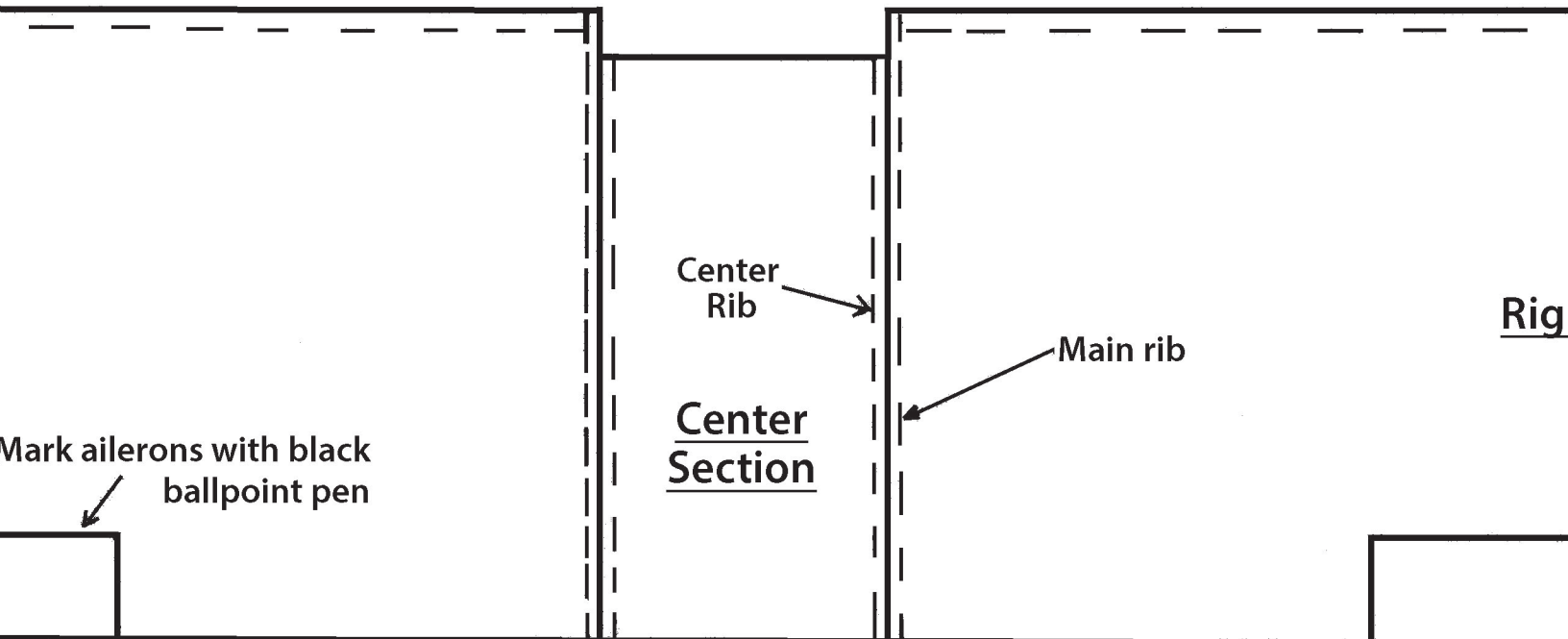
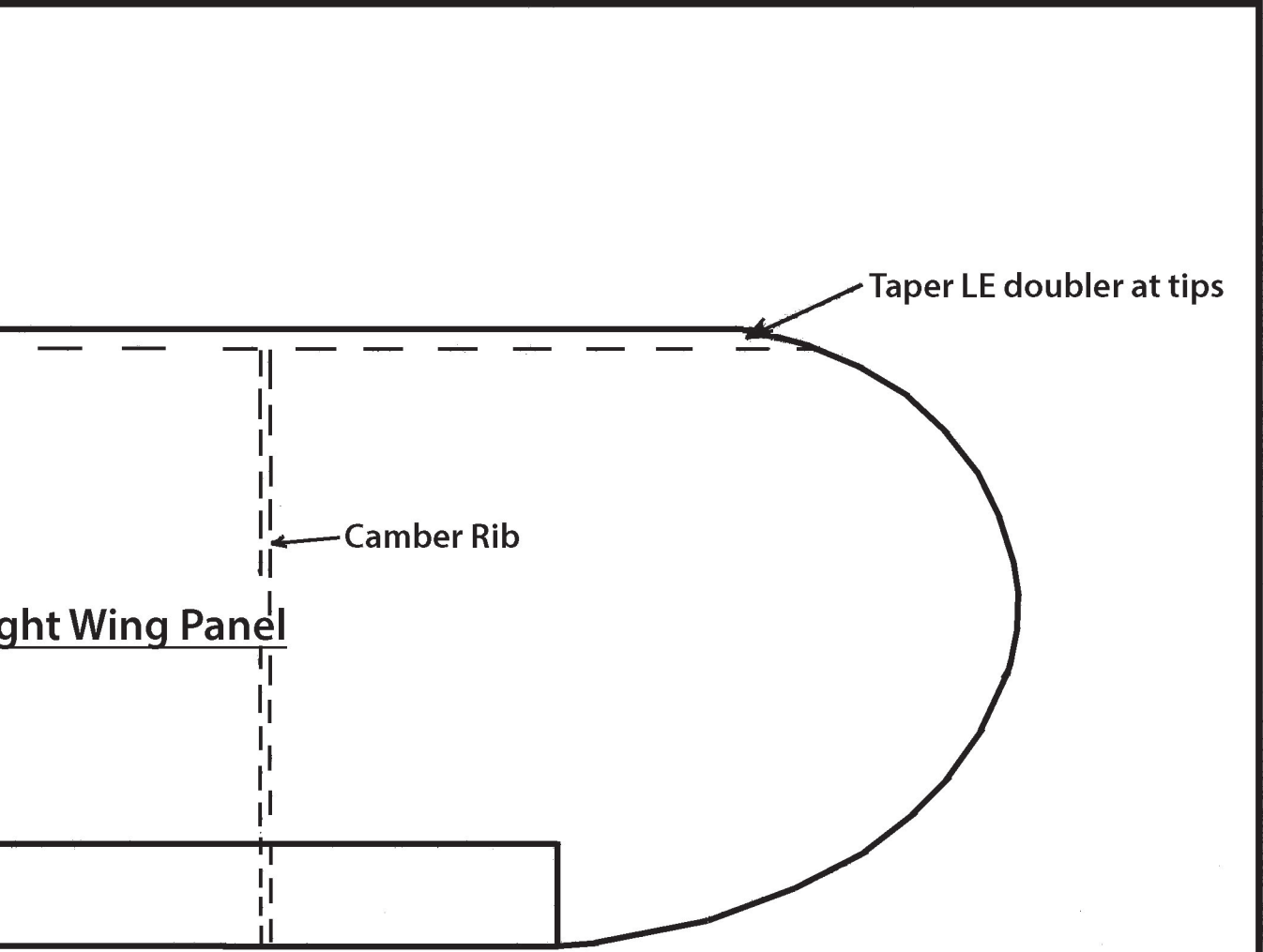

ght Wing Panel

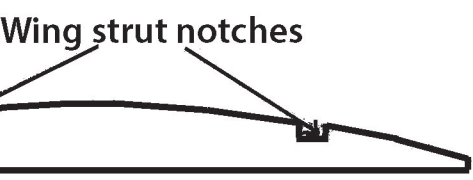

Note: Unless otherwise indicated, all parts are of 2mm Depron



Rear Top Deck

Rudder slot

1-1
(Open for
motor
mount)

3 laminations



Open to accommodate motor

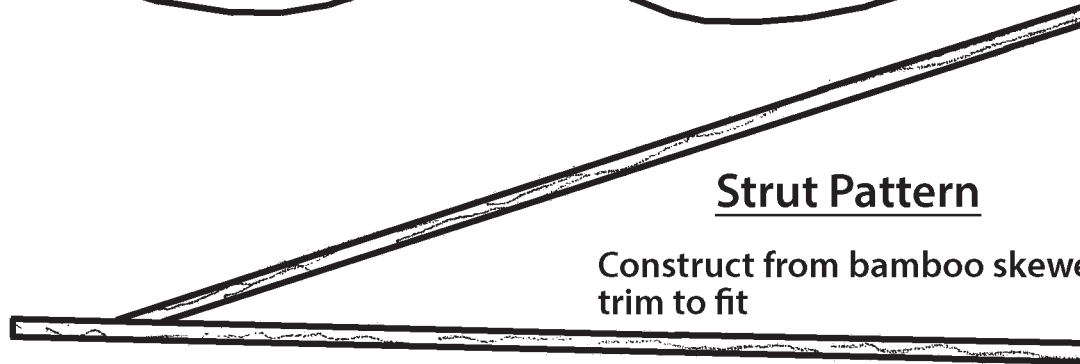
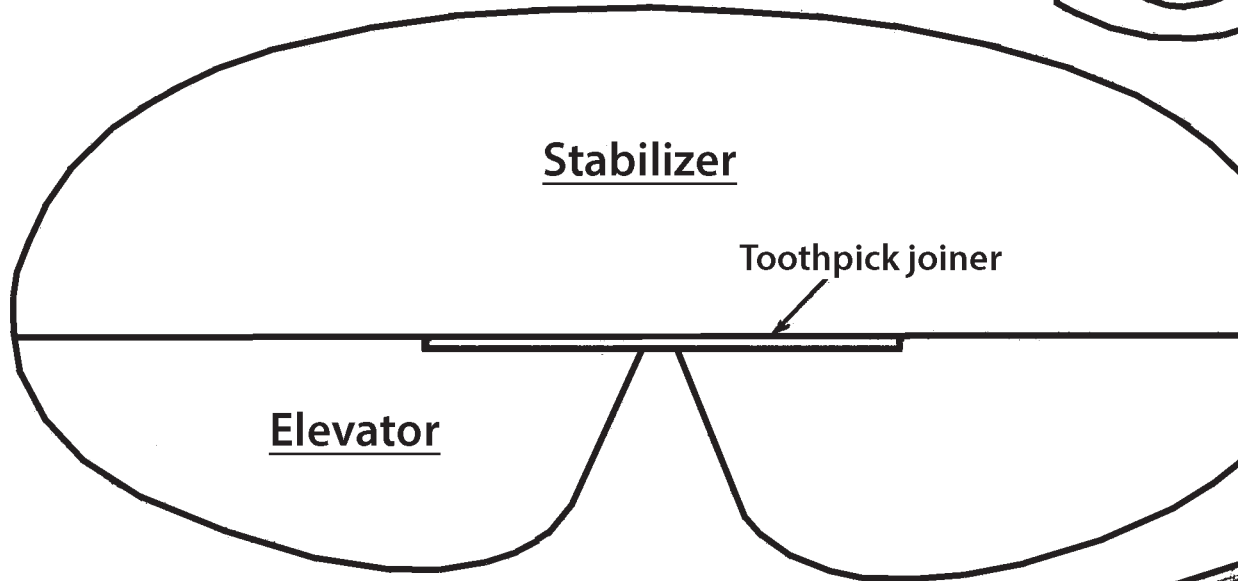
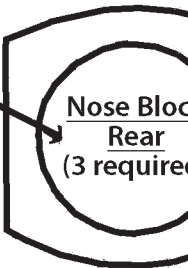

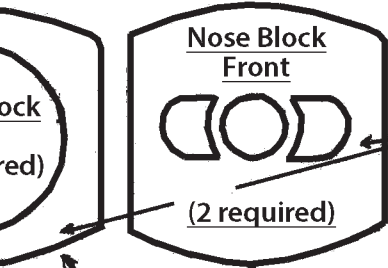
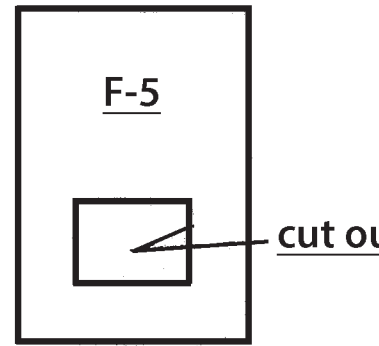
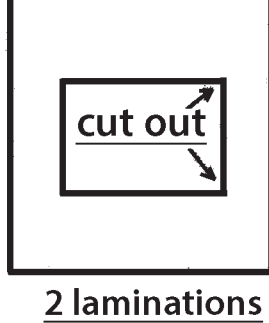
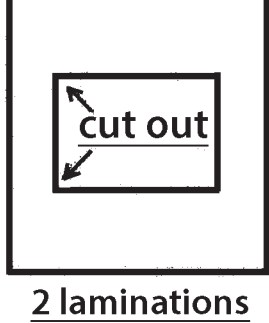

Note: Join all 5 noseblock laminations. Carve and sand to shape after mounting

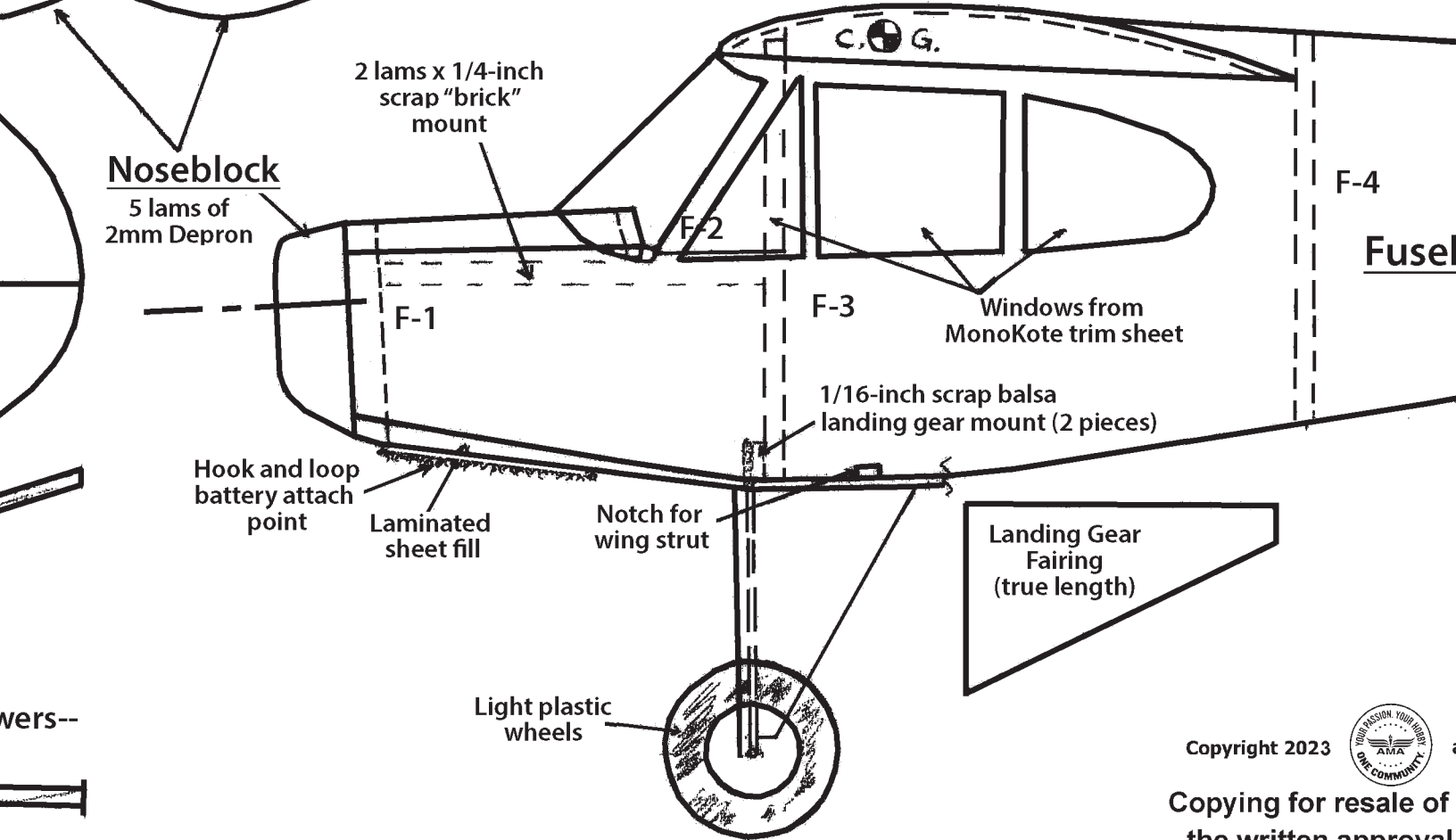

Copyright 2023



Copying for resale of the written approval is expressly

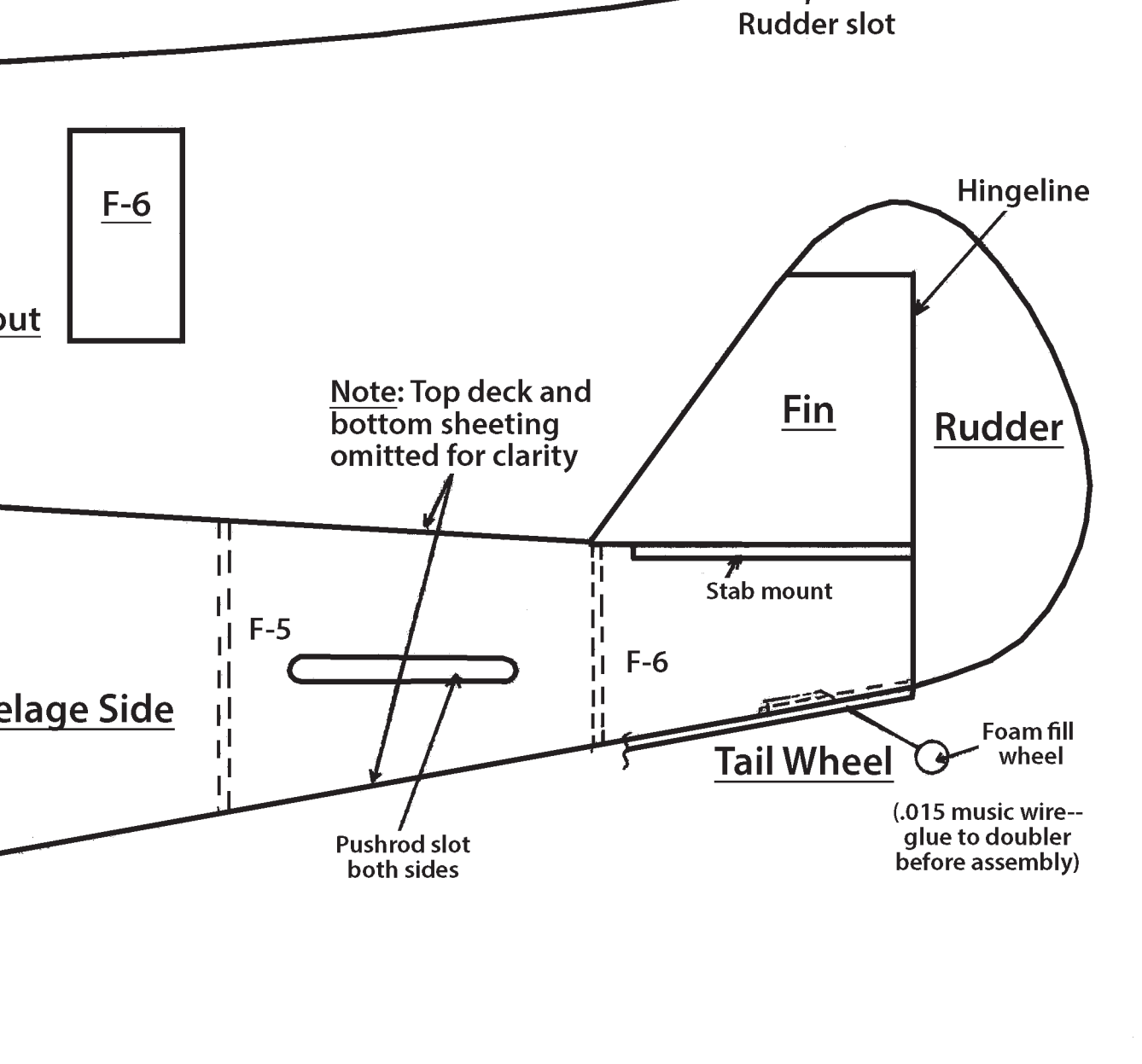

Micro "Super Cub" Plan No. 1135

For indoor and outdoor flying
 20-inch wingspan
 35 grams, less battery

Designed and drawn by:
 Larry Kruse April 2016

and **ModelAviation**
 of this drawing without
 al or consent of AMA
 y prohibited.