

GROOVE
1/16 DEEP
7 PLACES

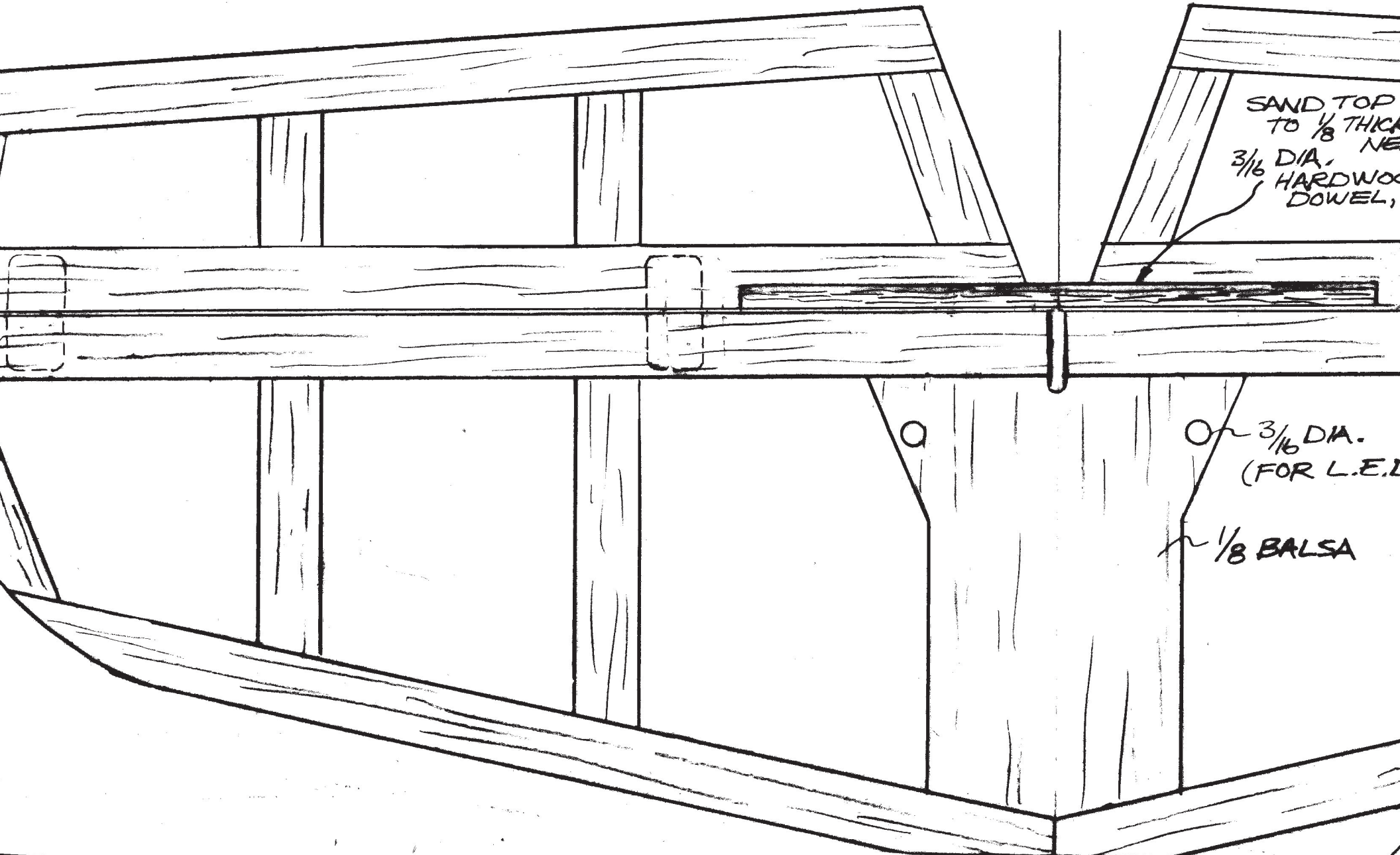

SAND TOP
TO 1/8 THICK
NE
3/16 DIA.
HARDWOOD
DOWEL,

3/16 DIA.
(FOR L.E.L.)

1/8 BALSA

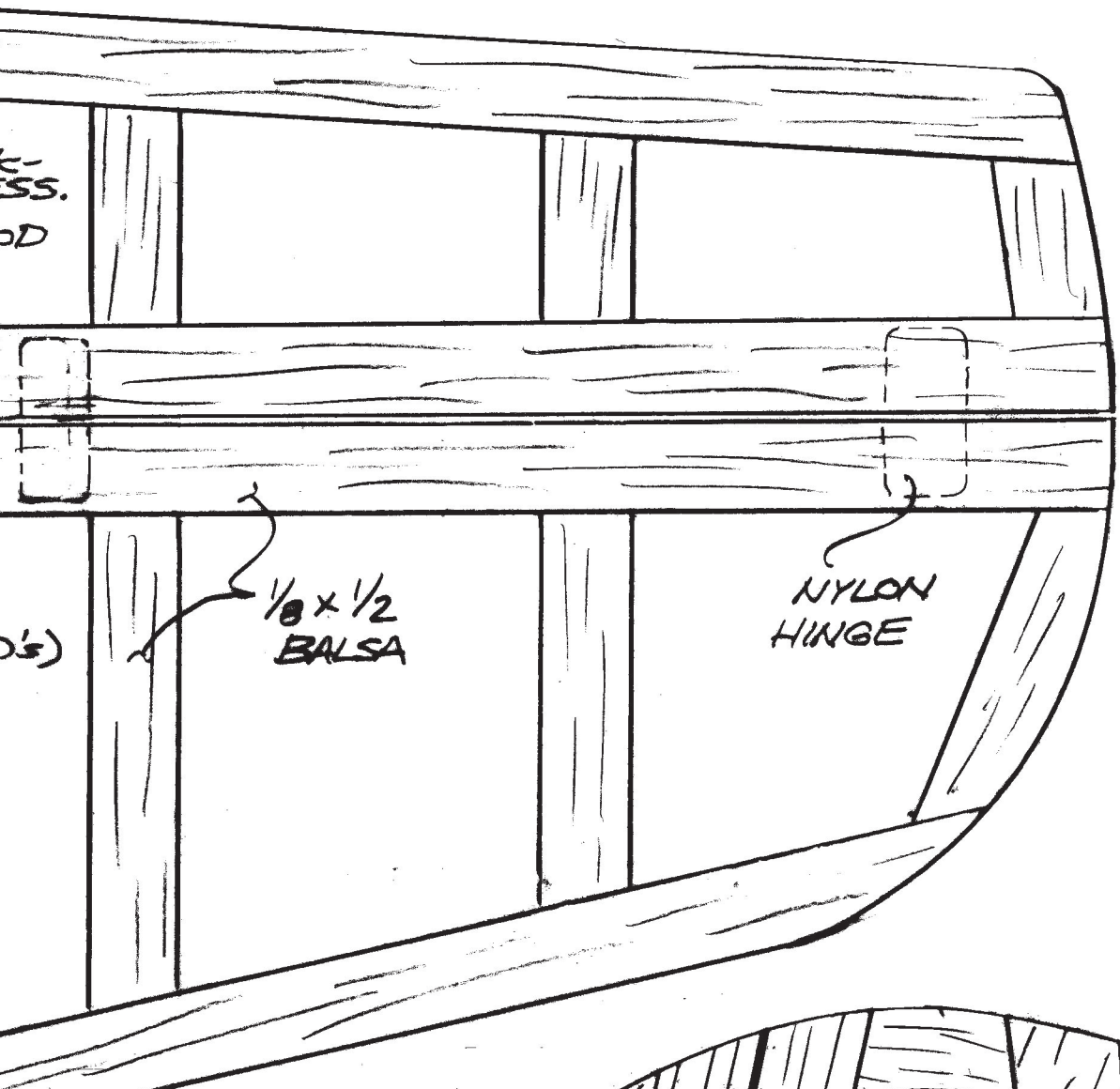

SS.
OD

(5)

$\frac{1}{8} \times \frac{1}{2}$
BALSA

NYLON
HINGE

$\frac{3}{32}$ (2)
BALSA BATT.

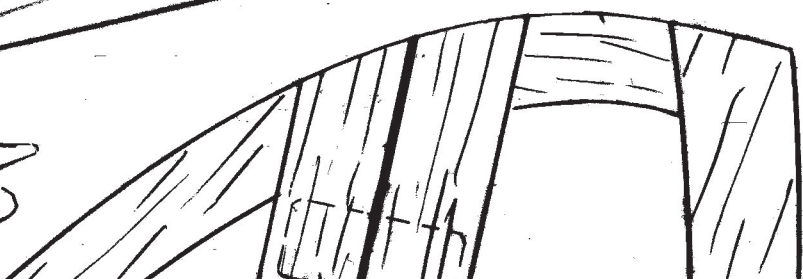

3/32
BALSA

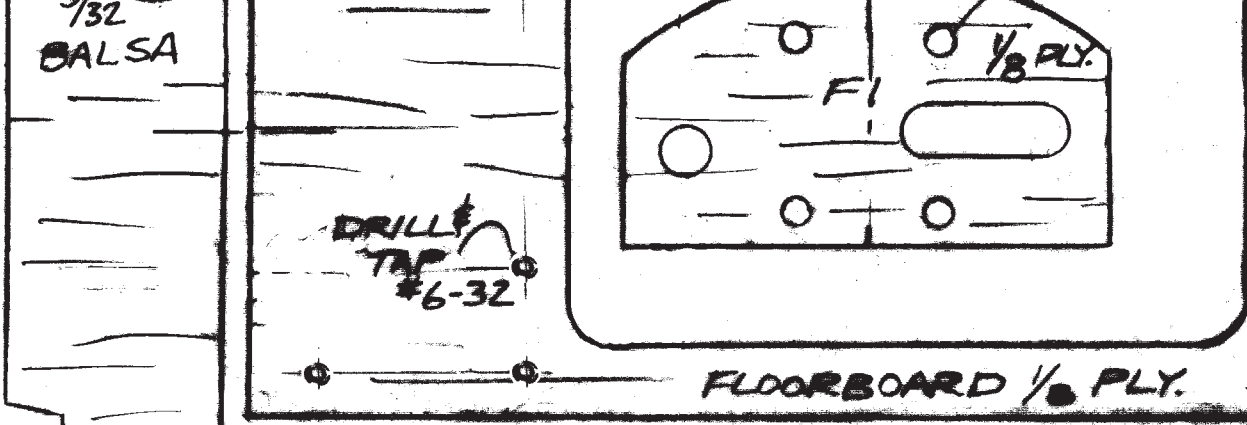

DRILL
TAP
#6-32

FLOORBOARD 1/8 PLY.

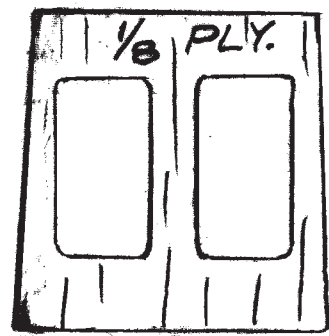

ELEV. RUD.
SERVO
MOUNT

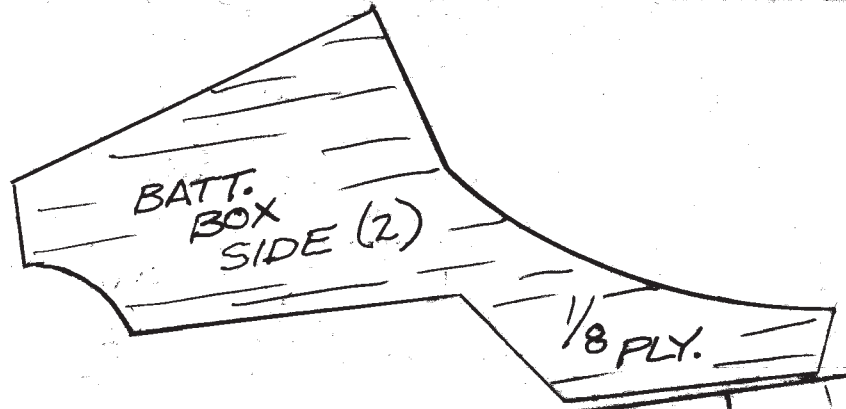

BATT.
BOX
SIDE (2)

1/8 PLY.

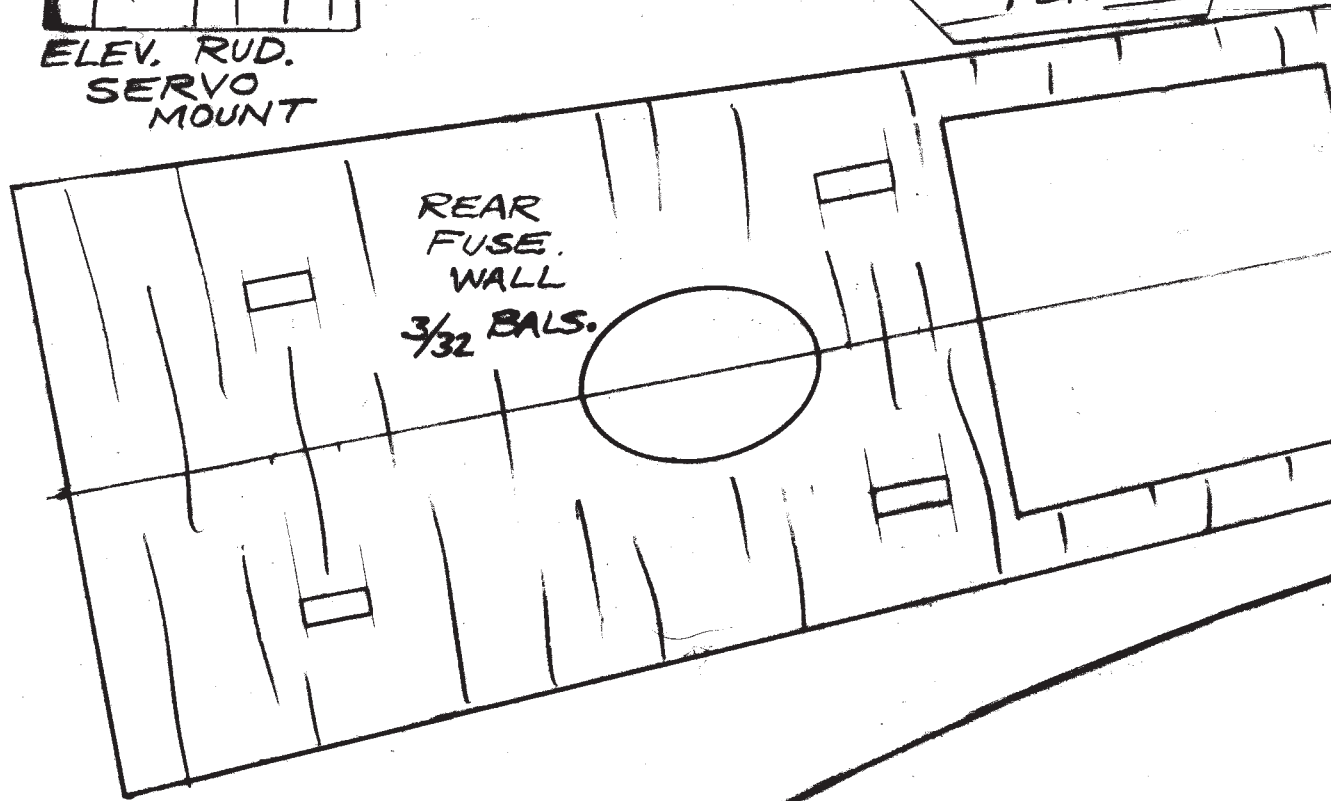

REAR
FUSE
WALL
3/32 BALS.

BATTERY
TO
ESC
HOLE

AAA BATTERY
ACCESS
PANEL

7/32
DIA.

#6-32
THREAD



GLUE TOGETHER
BEFORE THREADING

BATTERY STOP
(3) 1/8 PLY.
STACKED

INSIDE
WALL OF
BATT.
BOX

1/8 PLY.

NOSE
WHEEL
SERVO
MOUNT

SEAT
BACK
(2)

BALSA
BLOCK

MOTOR
MOUNT TOP
3/32 BALSA

CUT
IN 30°

C.G.



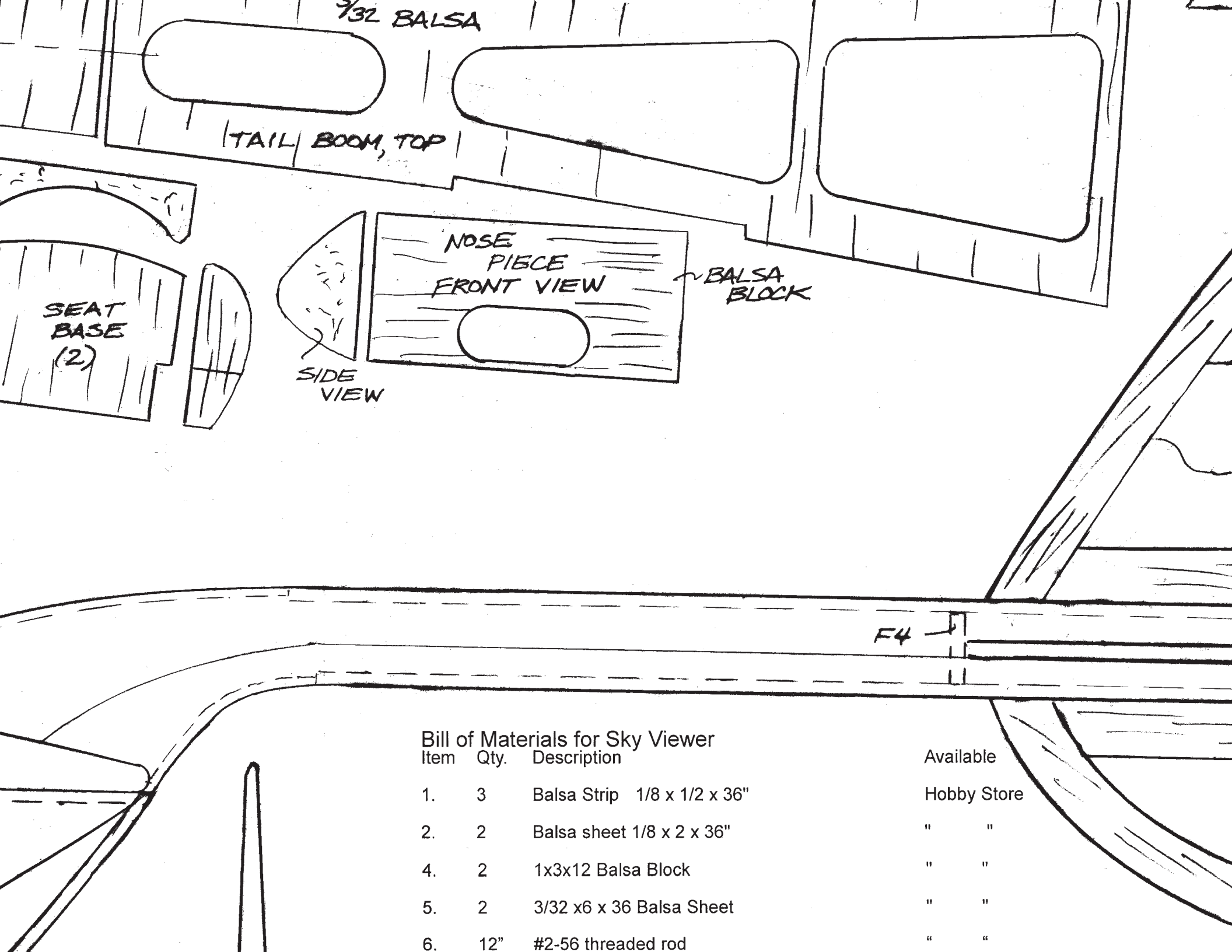

3/32 BALSA

TAIL BOOM, TOP

SEAT
BASE
(2)

NOSE
PIECE
FRONT VIEW

SIDE
VIEW

BALSA
BLOCK

F4

Bill of Materials for Sky Viewer

Item	Qty.	Description	Available
1.	3	Balsa Strip 1/8 x 1/2 x 36"	Hobby Store
2.	2	Balsa sheet 1/8 x 2 x 36"	" "
4.	2	1x3x12 Balsa Block	" "
5.	2	3/32 x6 x 36 Balsa Sheet	" "
6.	12"	#2-56 threaded rod	" "

BOX
FILLER

NYLON
HINGE

$\frac{1}{8} \times \frac{1}{2}$

$\frac{1}{8}$ BALSA

BALSA

F5

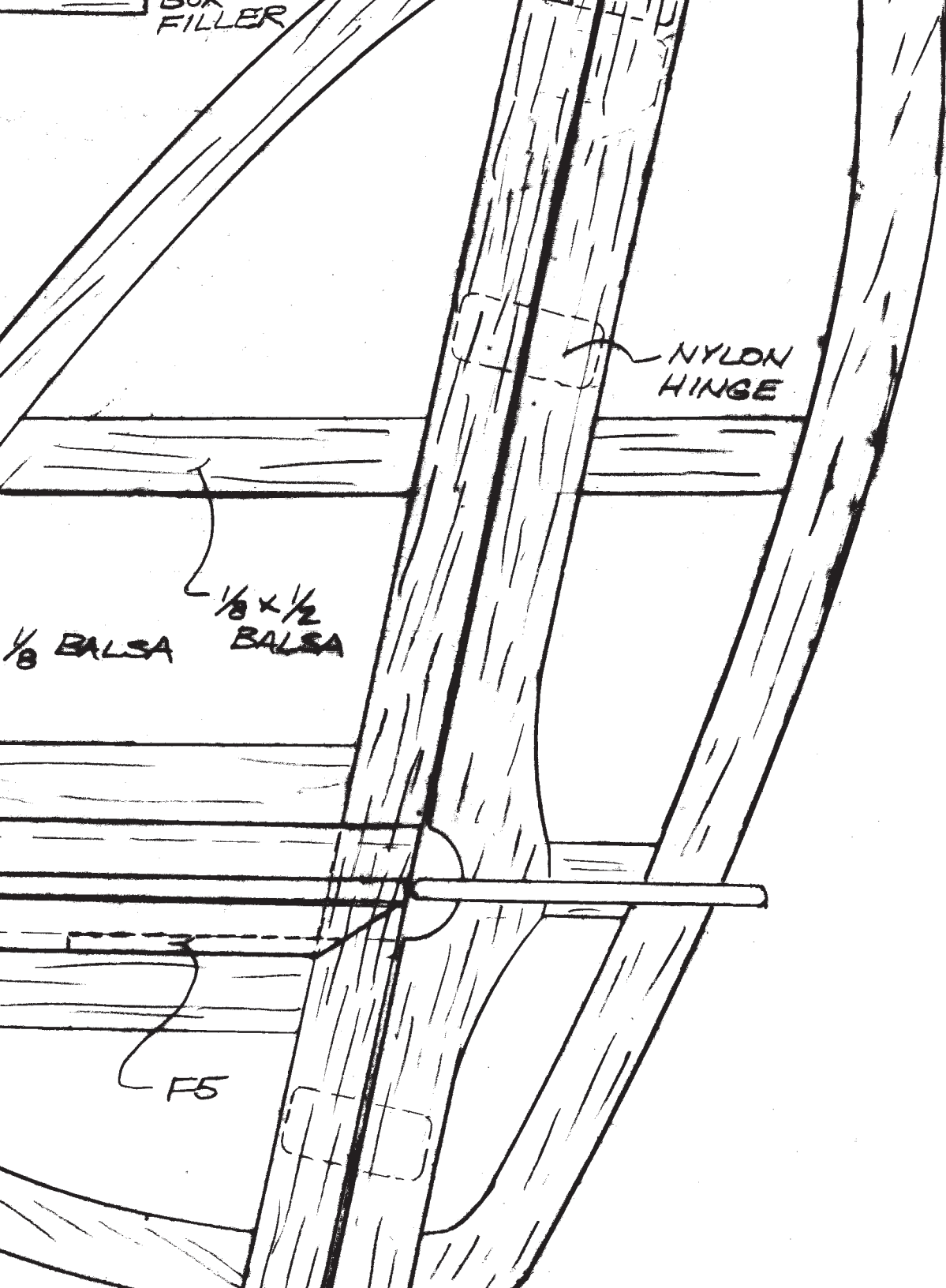

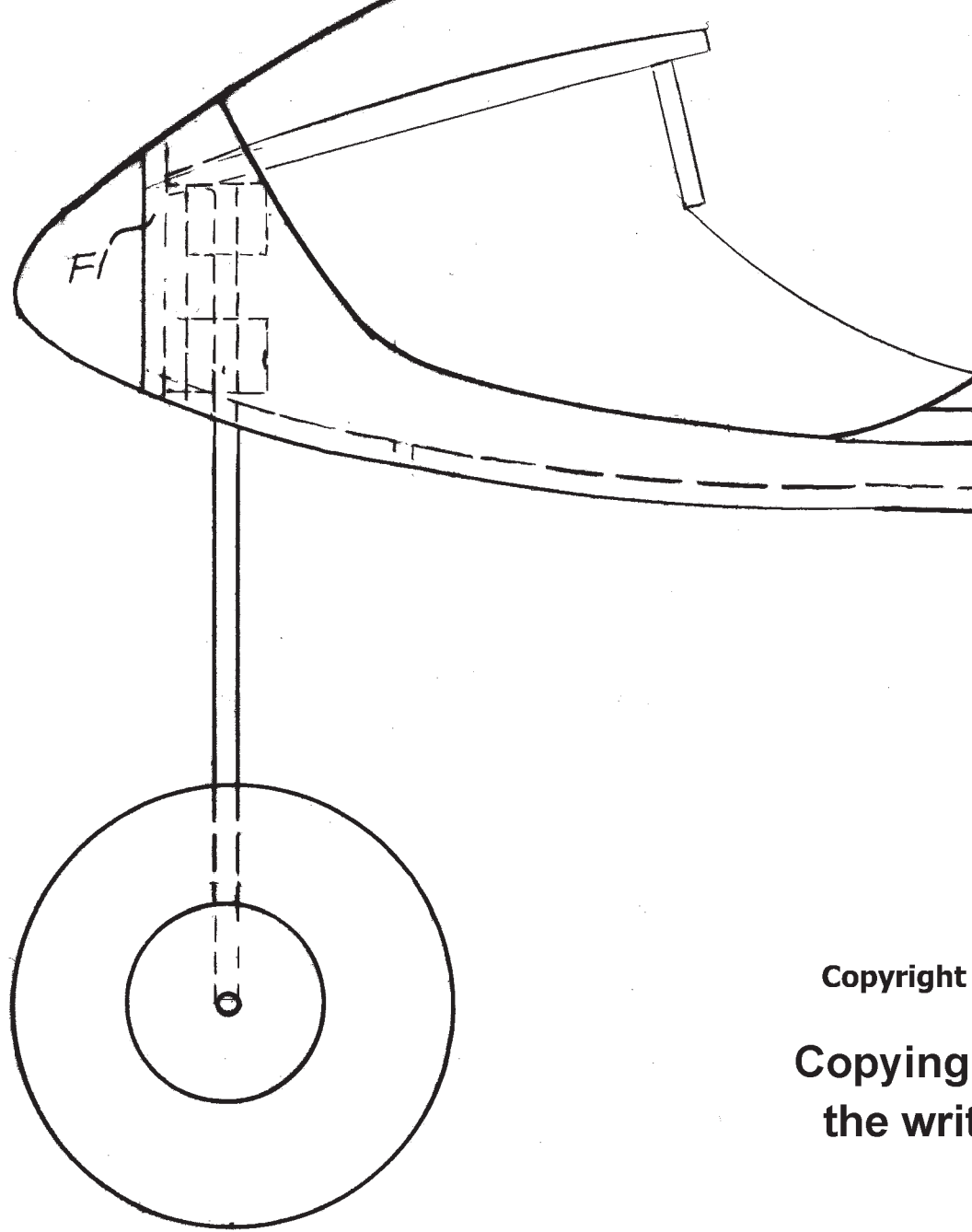

Copyright
Copying
the writ

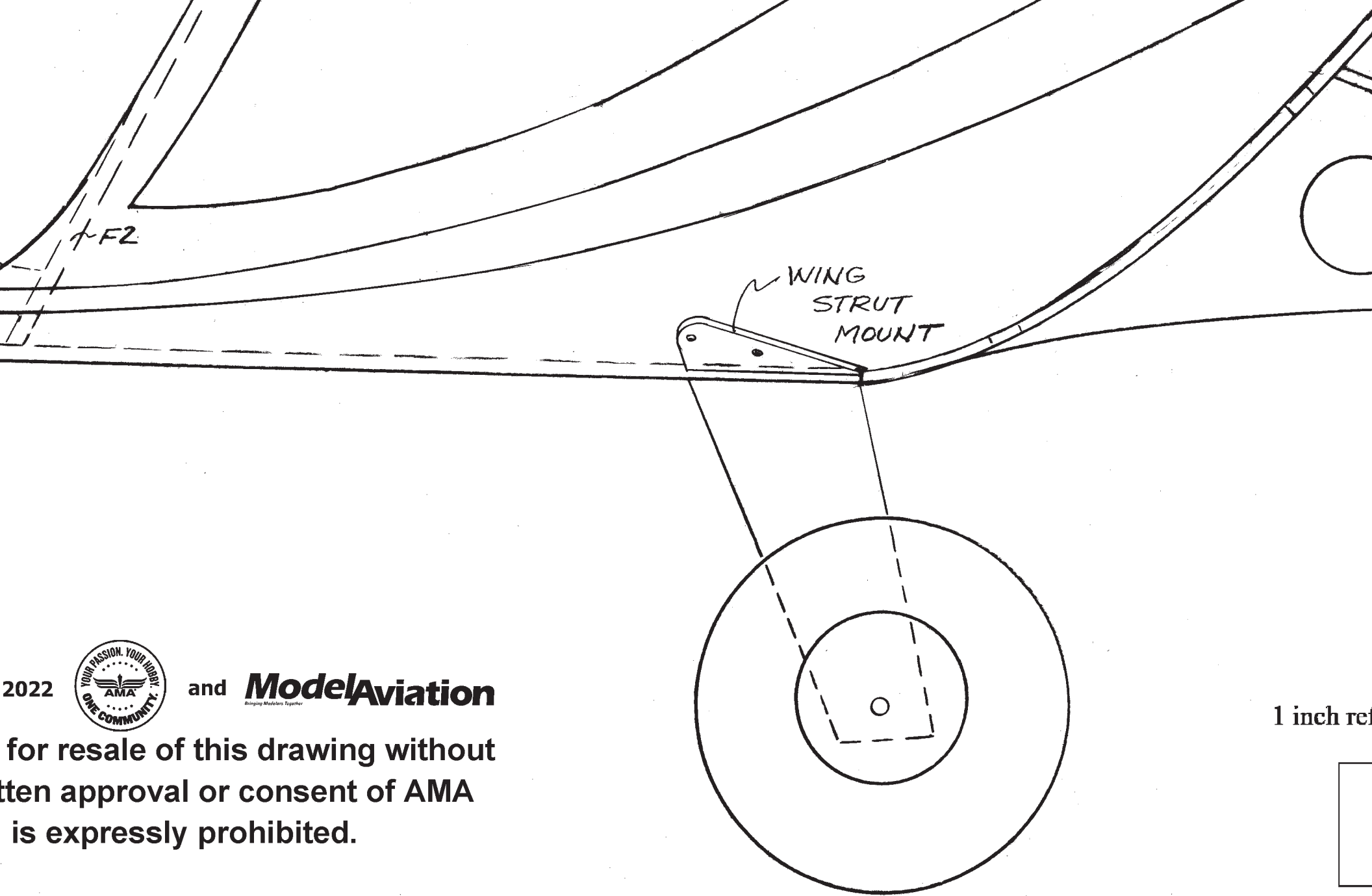

2022



and **ModelAviation**
Bringing Modelers Together

for resale of this drawing without
written approval or consent of AMA
is expressly prohibited.

1 inch ref

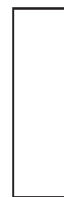

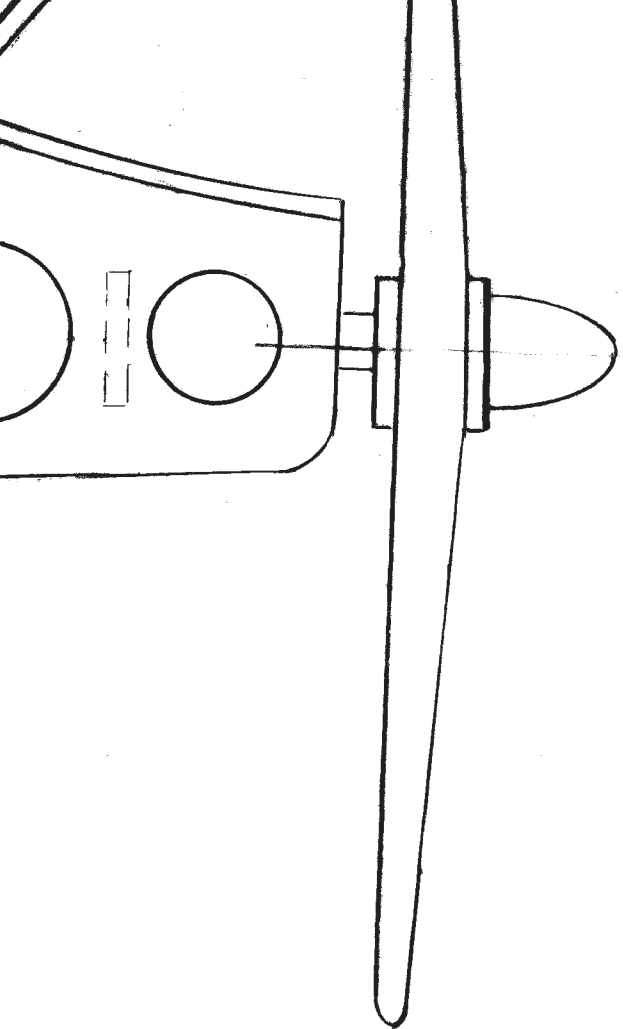

reference square

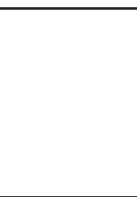

7.	2	1/4 diameter x 36 long hardwood dowel	"	"		
8.	2	3/16 diameter x 36 long hardwood dowel	"	"		
9.	1	1/8 x 12 x 24 aircraft plywood	"	"	27.	1
					28.	1
10.	4 pkg.	Kwik-Link Clevis #2-56 thread #DUB 109	Horizon Hobby		29.	1
11.	1 pkg.	Nylon Hinges DuBro #119	ph. 888-959-2307		31.	1 pkg.
12.	1	E-flite 370 brushless outrunner motor 1080 KV	"	"	32.	2
13.	1	E-flite (ESC) 20 Amp, for brushless	"	"	33.	12
					34.	1
14.	1	E-flite Batt. 3s 800 mah, JST #VNR25051 , Spektrum #SPMX8003SJ50			35.	7
15.	1	Radio and receiver, 3 channel minimum	"	"	36.	4
16.	4	#10-40 Allen hd. Screws	"	"	37.	25 ft.
17.	4	#10-40 Nyloc Stop Nuts	"	"	38.	25 ft.
18.	1	Steerable Nose Gear DuBro #153	"	"	39.	1
19.	3	HiTec HS-55 Feather Servo	"	"		
20.	1 pkg.	Dubro SuperLite 3" Wheel # DUB 300SL	"	"		
21.	1 pkg.	Dubro SuperLite 2 1/2 Wheel #DUB 250SL	"	"		
22.	1 pkg.	Micro Control Horns Dubro #919	"	"		
23.	1	Y harness Horizon Hobby #EFL08261	"	"		
24.	2	Prop. 7-5 for electric #APC07050E	"	"		
25.	1 pkg.	1/8 Axle Shaft DUB 246	"	"		
26.	1 pkg.	Collar 1/8 (retain wheels) DUB 139	"	"		

Clear covering material HAN U964	" "
White covering material HAN U870	" "
Green covering material HAN U880	" "
Steel rods, 1/16 dia. x 12"	Hobby store
Nylon Bolt 1/4-20 x 1"	" "
Nylon screw #6-32 x 1"long	" "
3 battery holder AAA # 36-2480-ND	Digikey.com
White LED 5mm # QBL81W15C-WW	ph. 800-344-4539
Green LED 5mm # 1497-XLVG12D-ND	" "
30 AWG Green wire # CN379G-25	" "
30 AWG Black wire # CN379B-25	" "
landing gear, windshield. gauges	clarksalisbury@hotmail.com

Sheet 1 of 2 Plan No. 1131

Sky Viewer

WINGSPAN 41" HEIGHT 17" LENGTH 33 1/2"

WEIGHT 27.5 OZ. WING AREA 399 SQ. IN.

WING LOADING .069 OZ./SQ INCH 3 CHANNEL

MOTOR - E-FLITE 370 1080 KV BATTERY 11.1V 800 MAH

DESIGNED & DRAWN CLARK SALISBURY 2021