

| Block

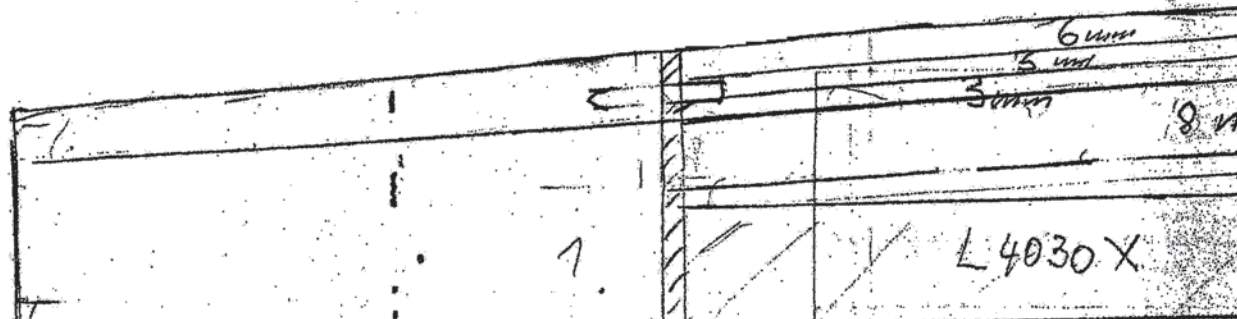

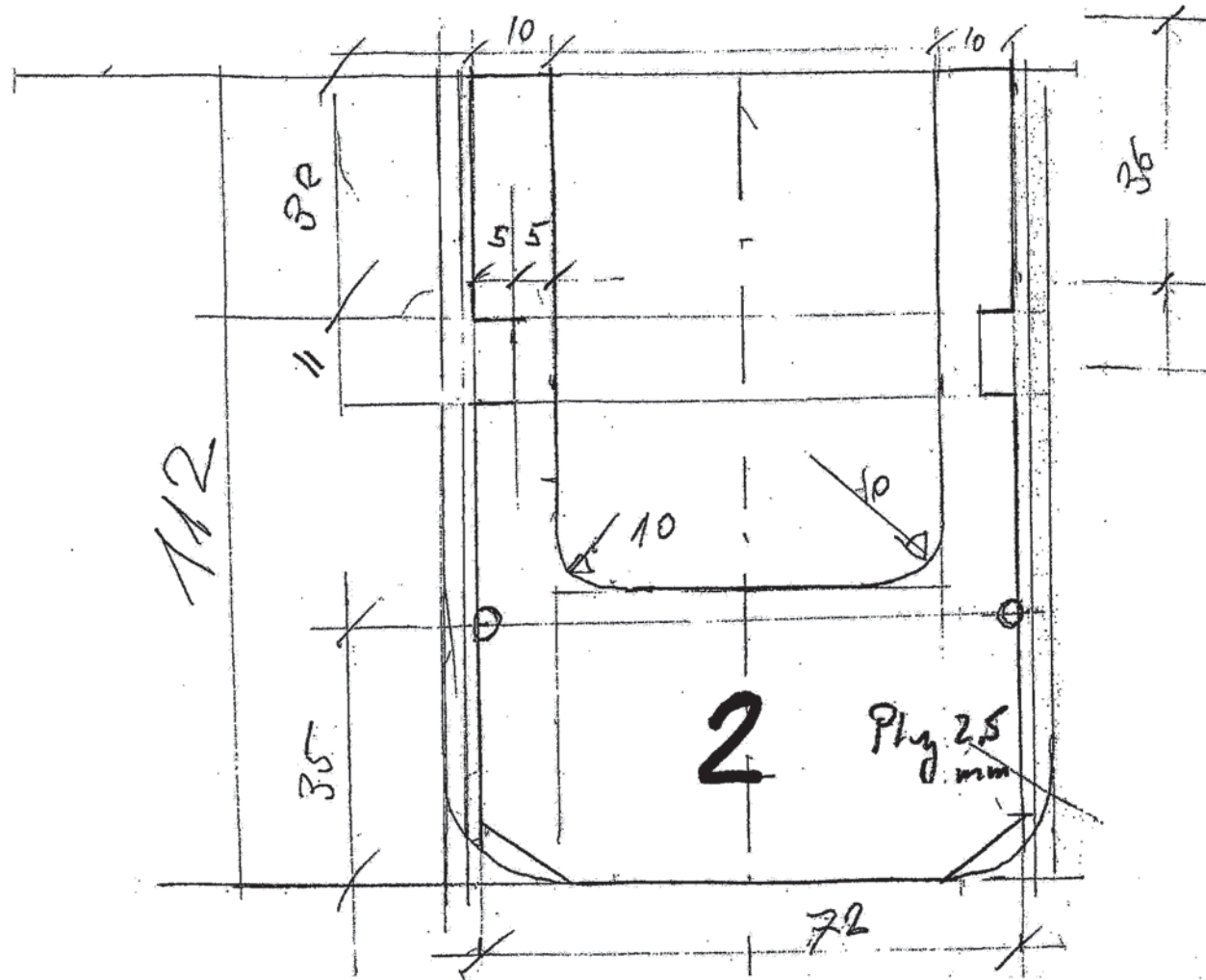

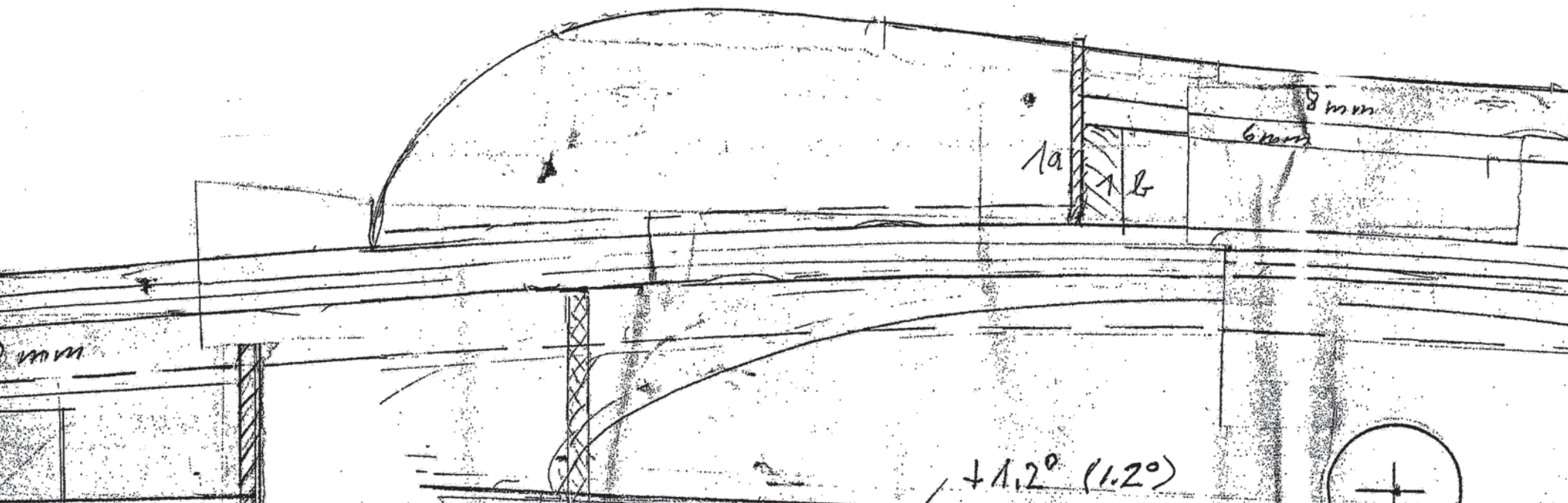

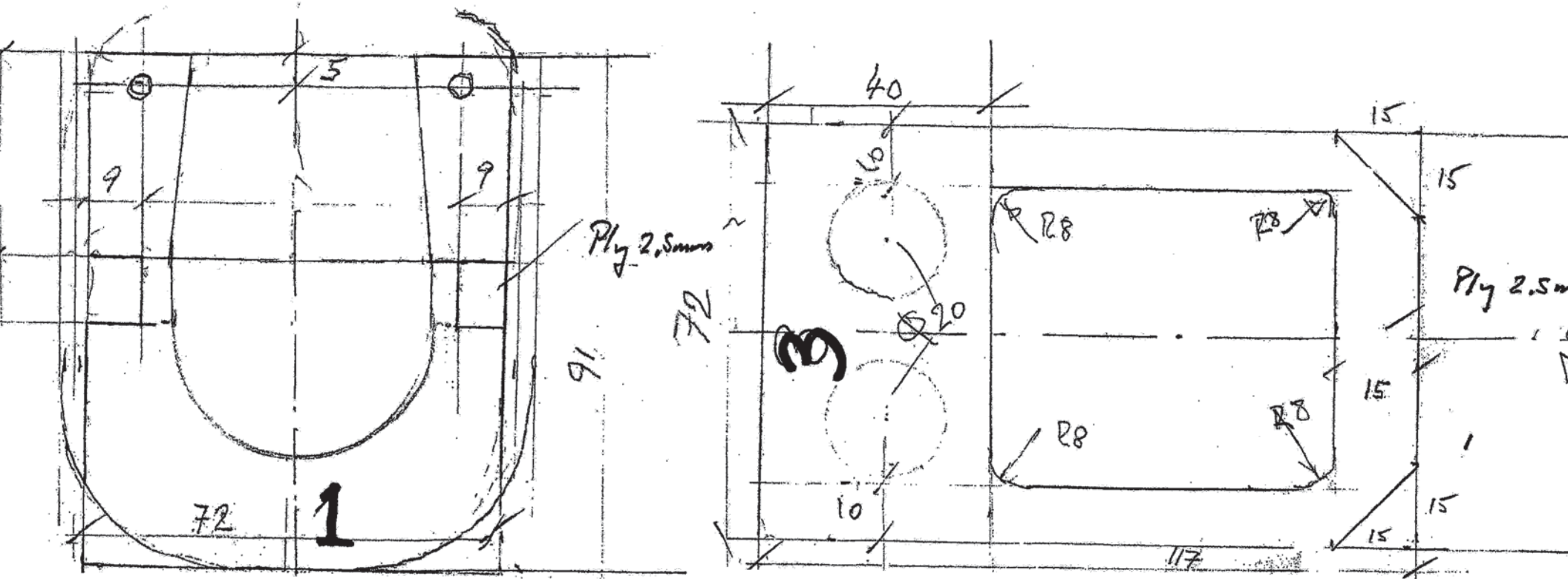
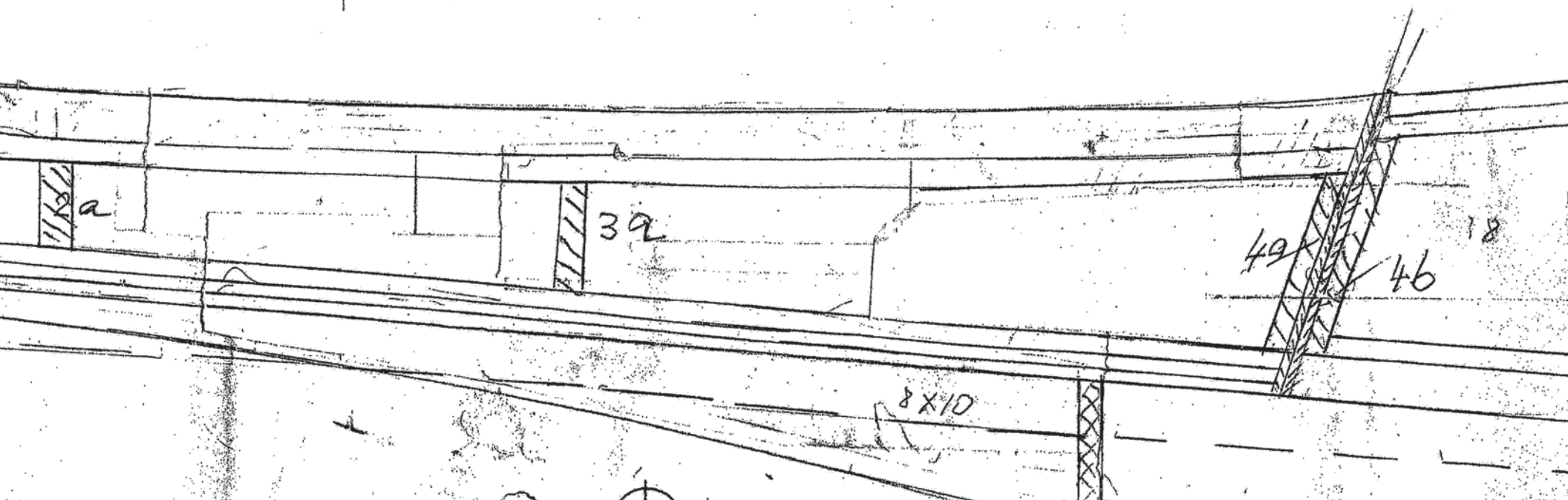
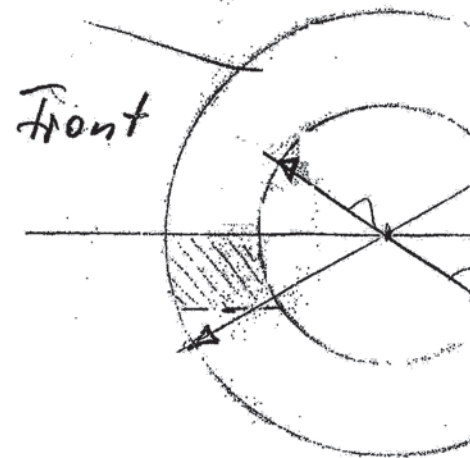
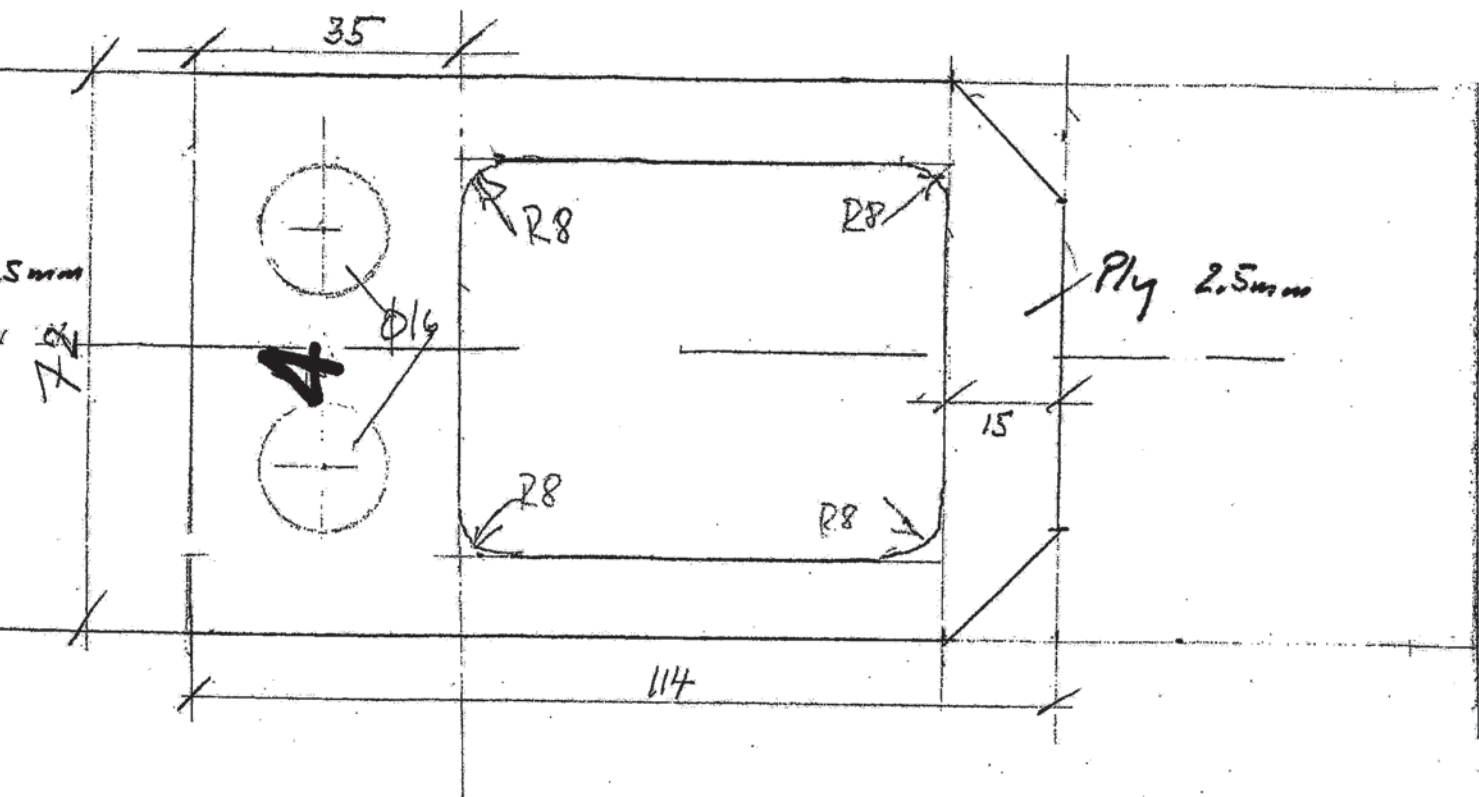

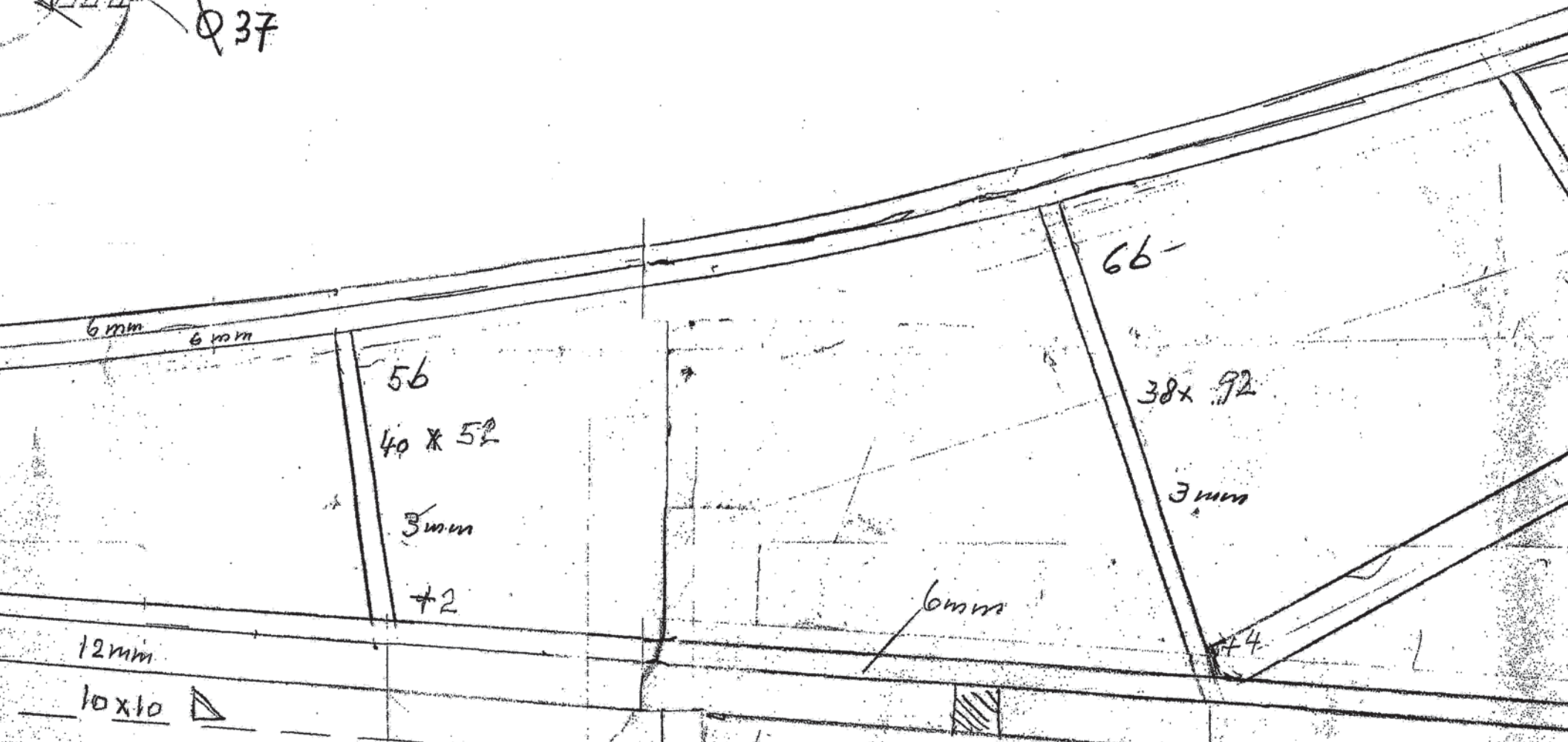
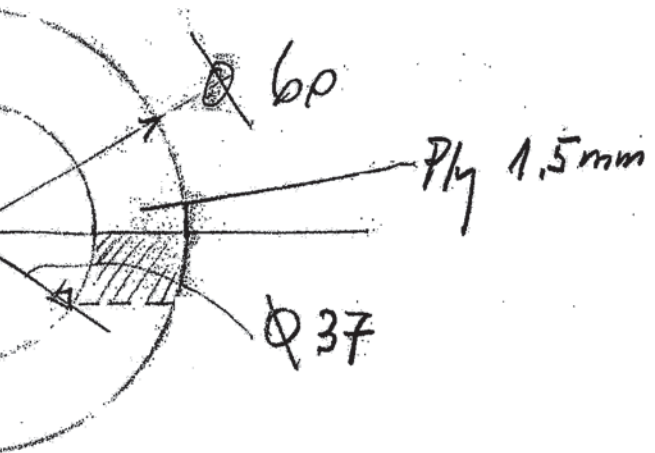

0°

Naca 00

30 x 22

36 x 2

3mm 96

38 x 222

86

36 x 44

76

3mm

3mm

46

Englerisle

17 = 2-8

3/22 mit ...



DLOCK

7012

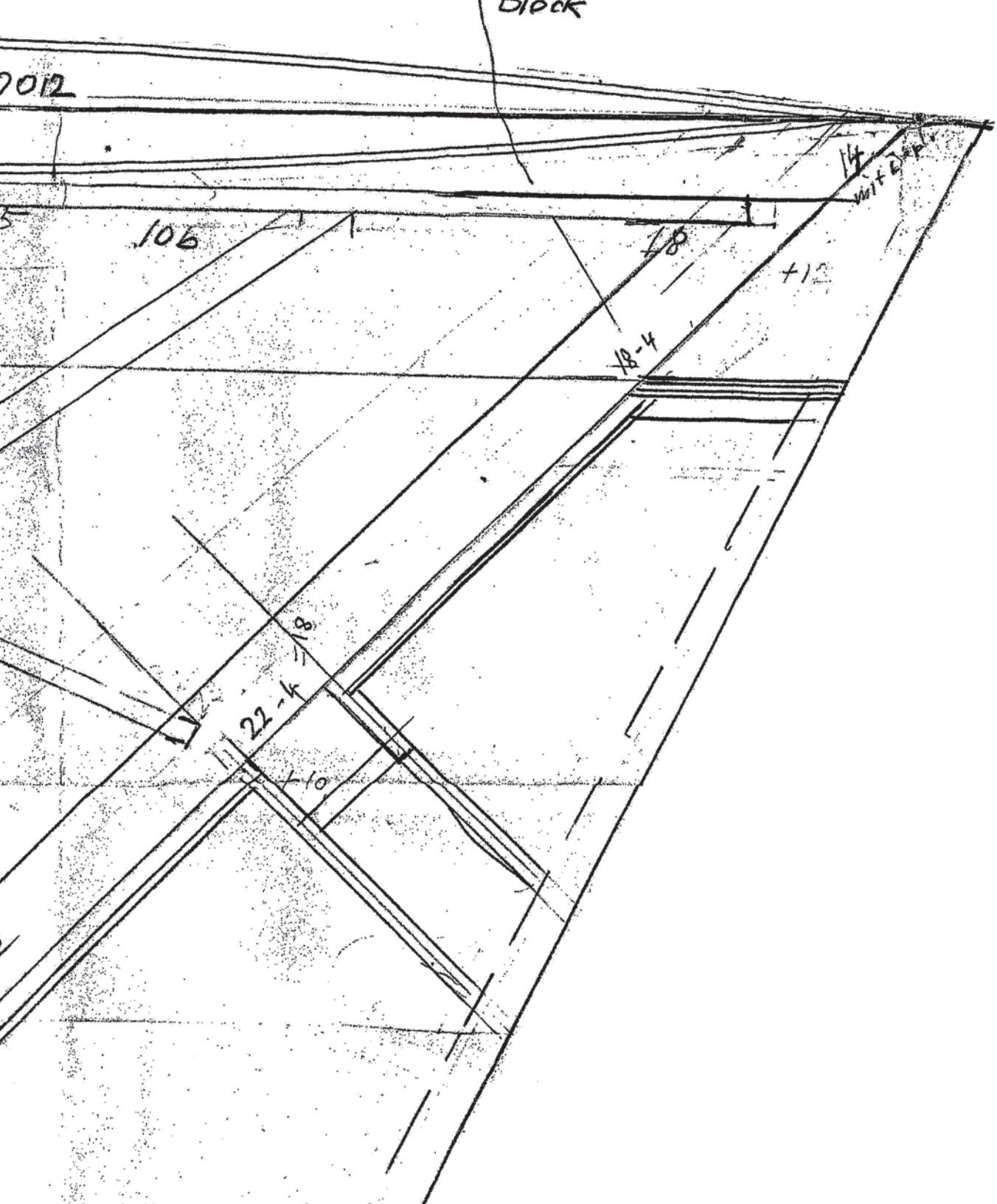

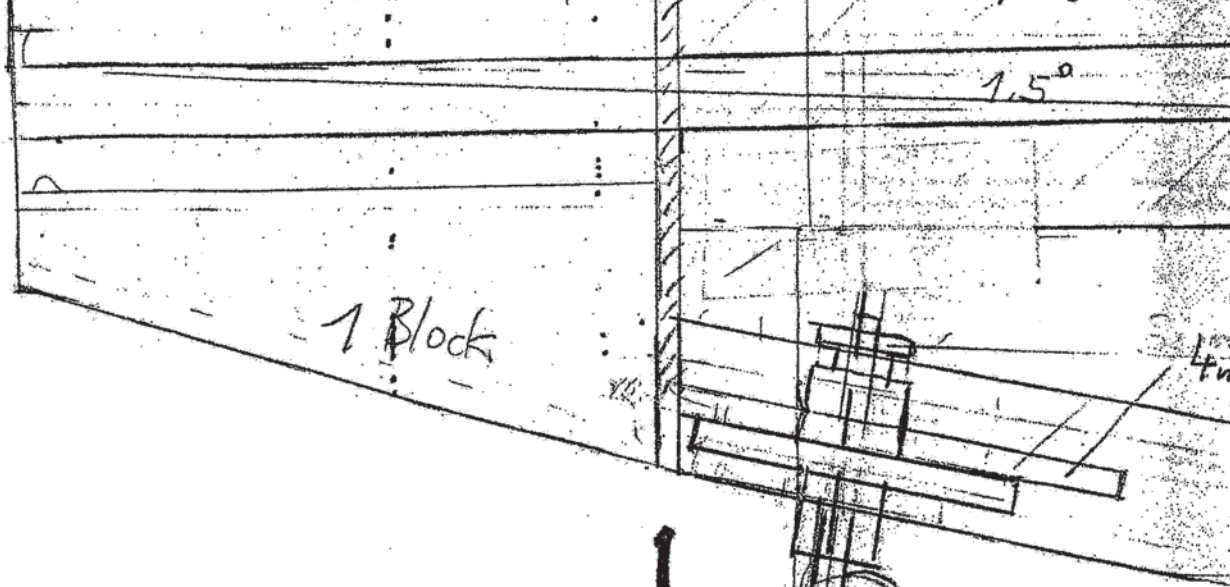

1

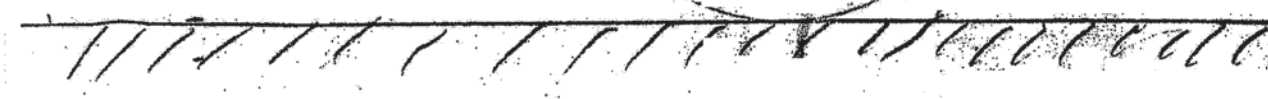
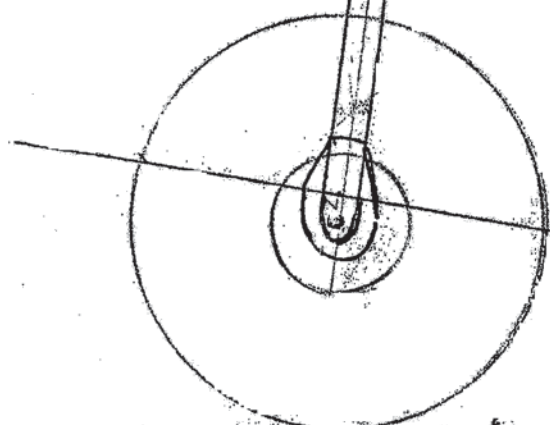

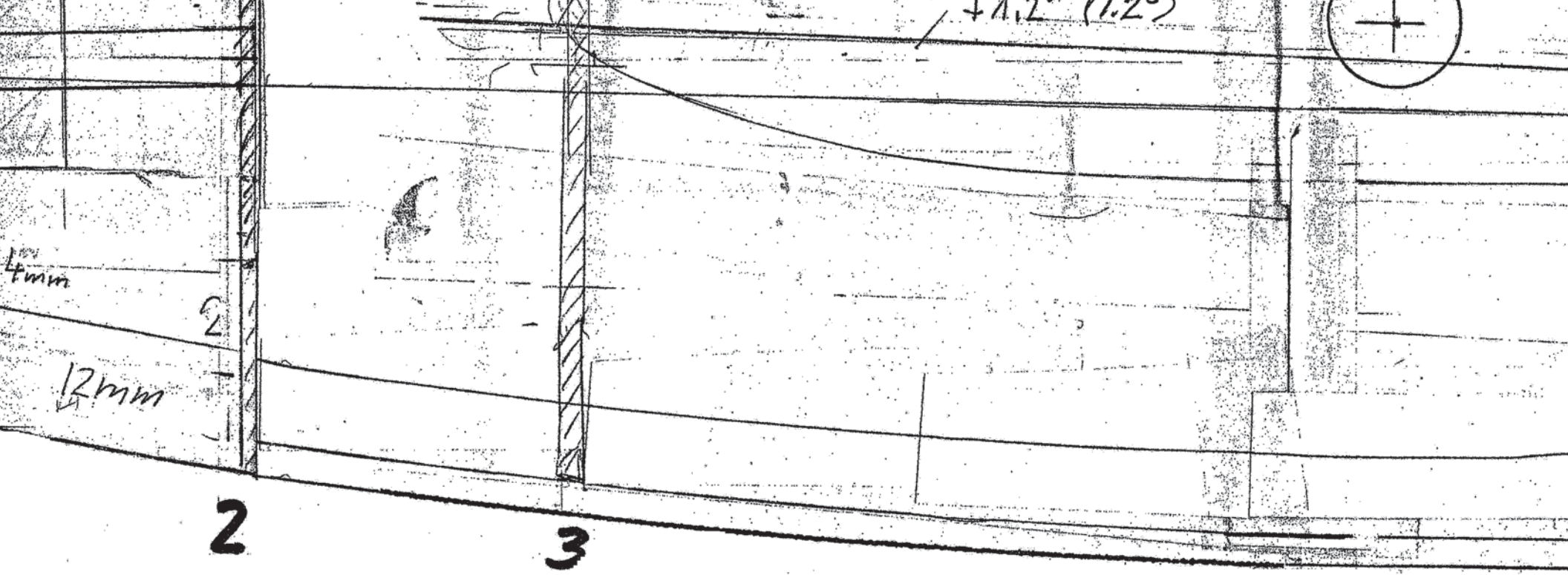

1111



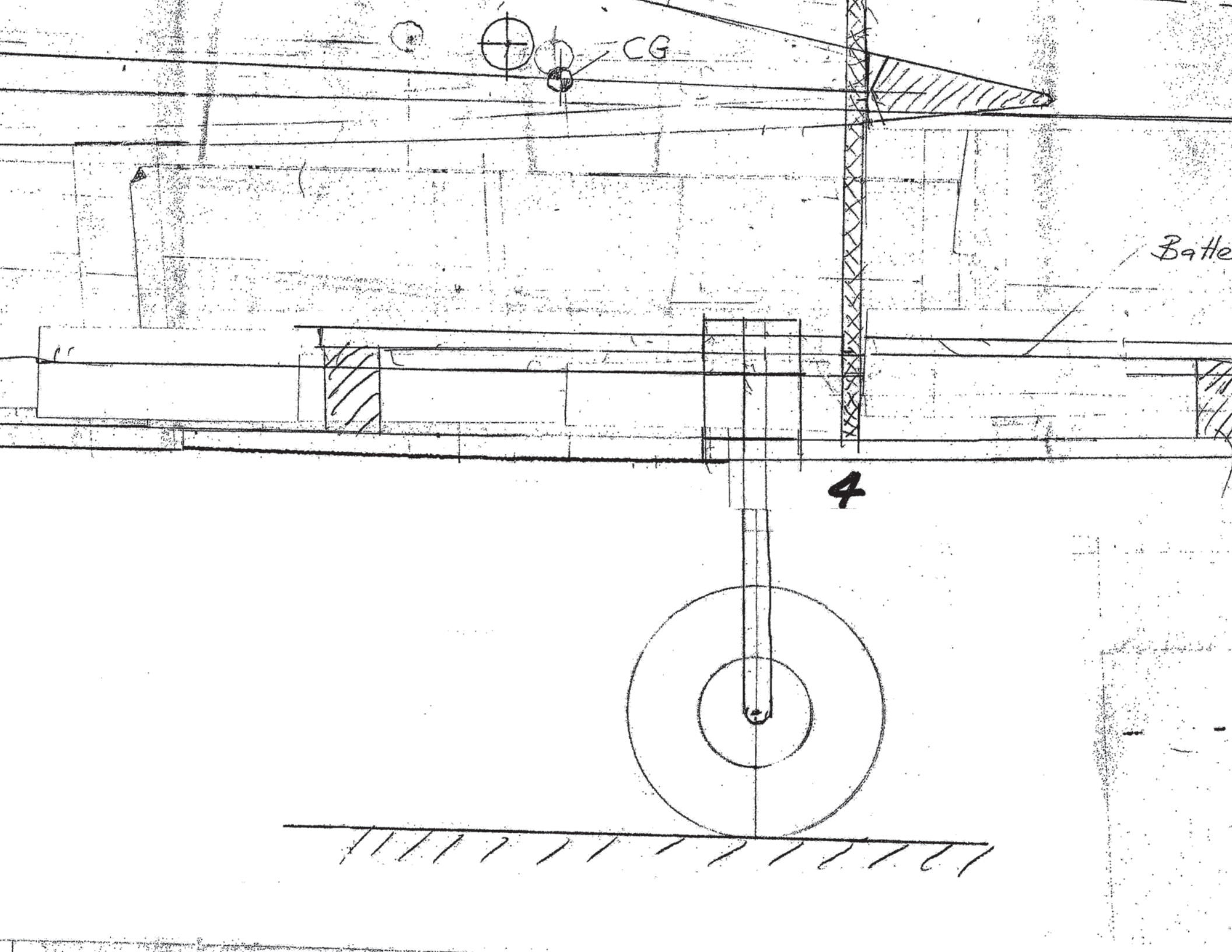

Herie



15 X 15

für Alkubrett

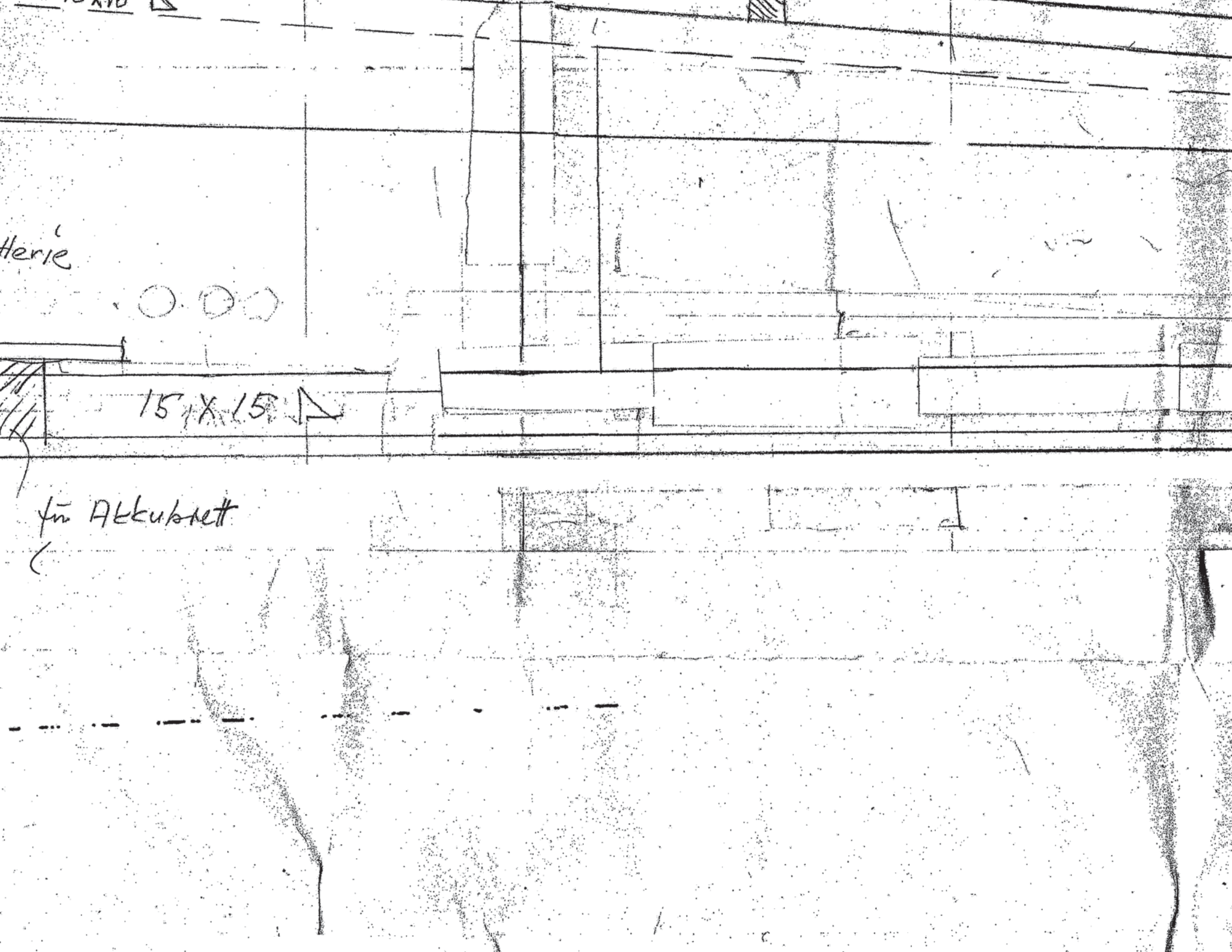



2/28 mit Deckentung  
6<sup>2+</sup>

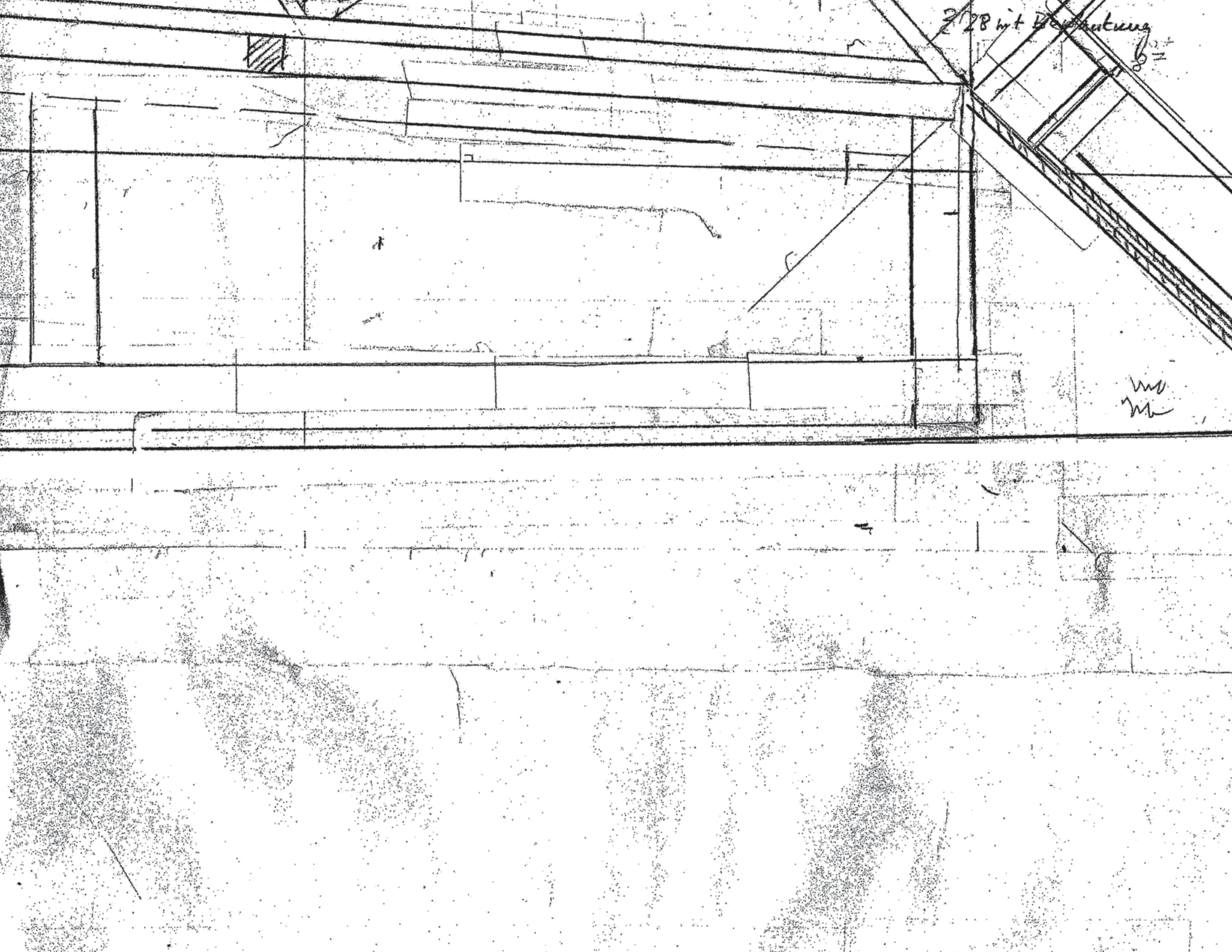

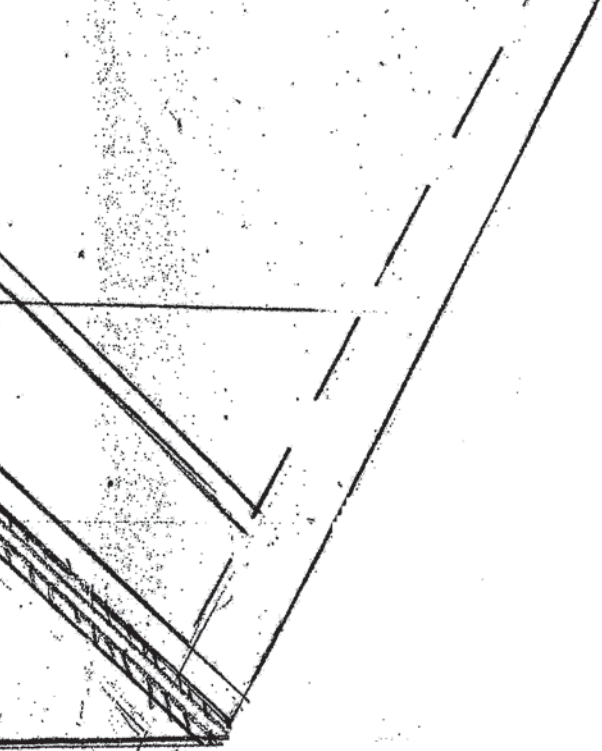

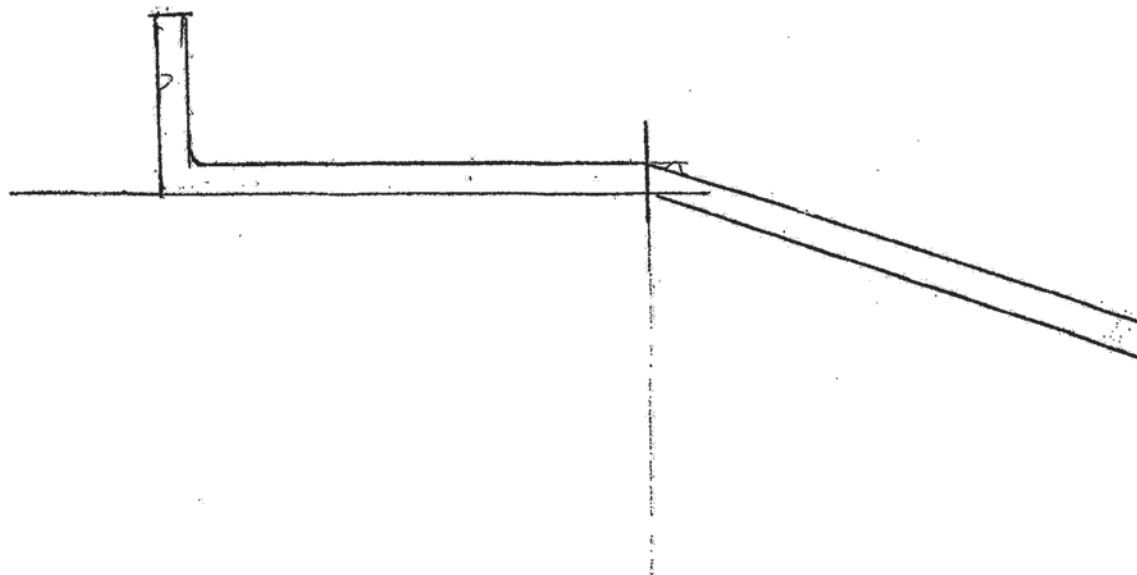
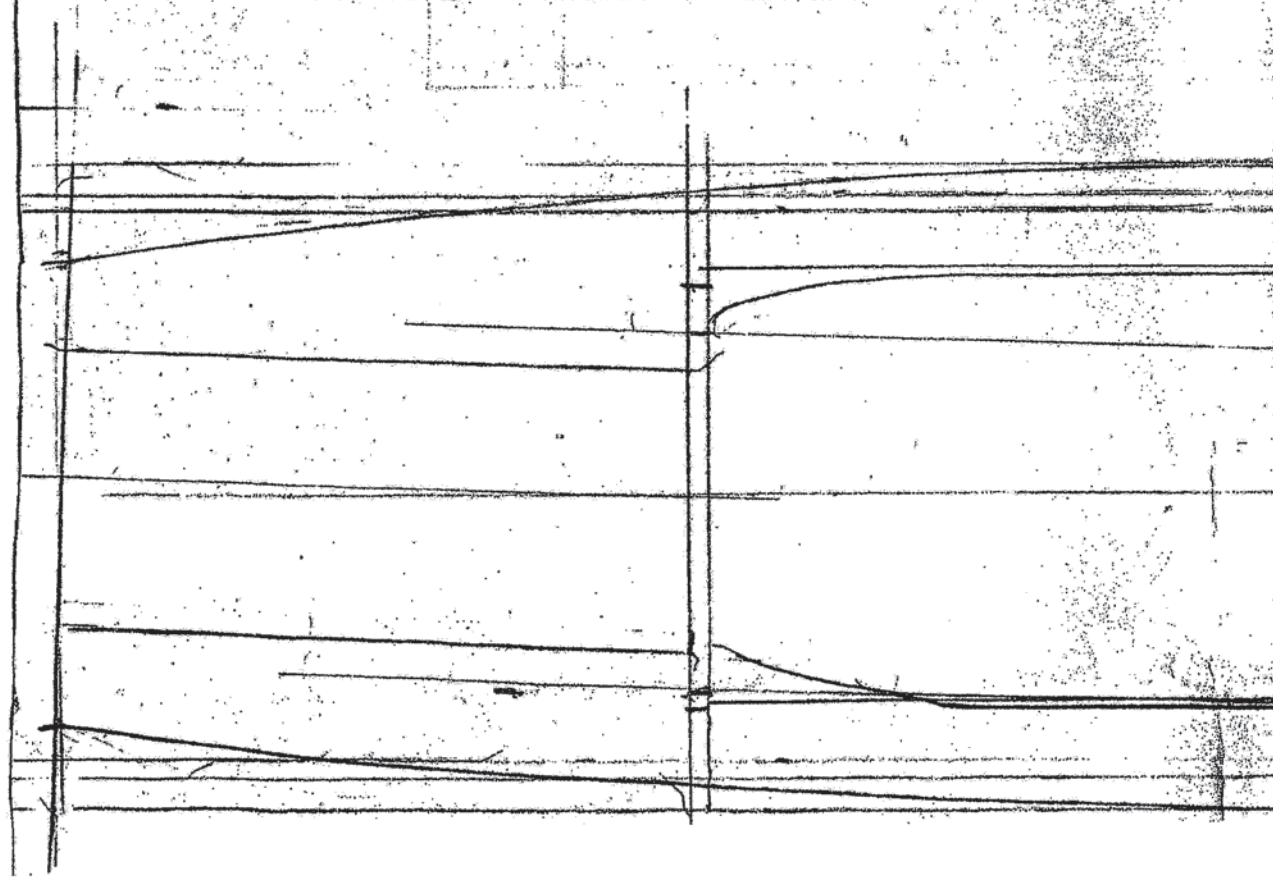



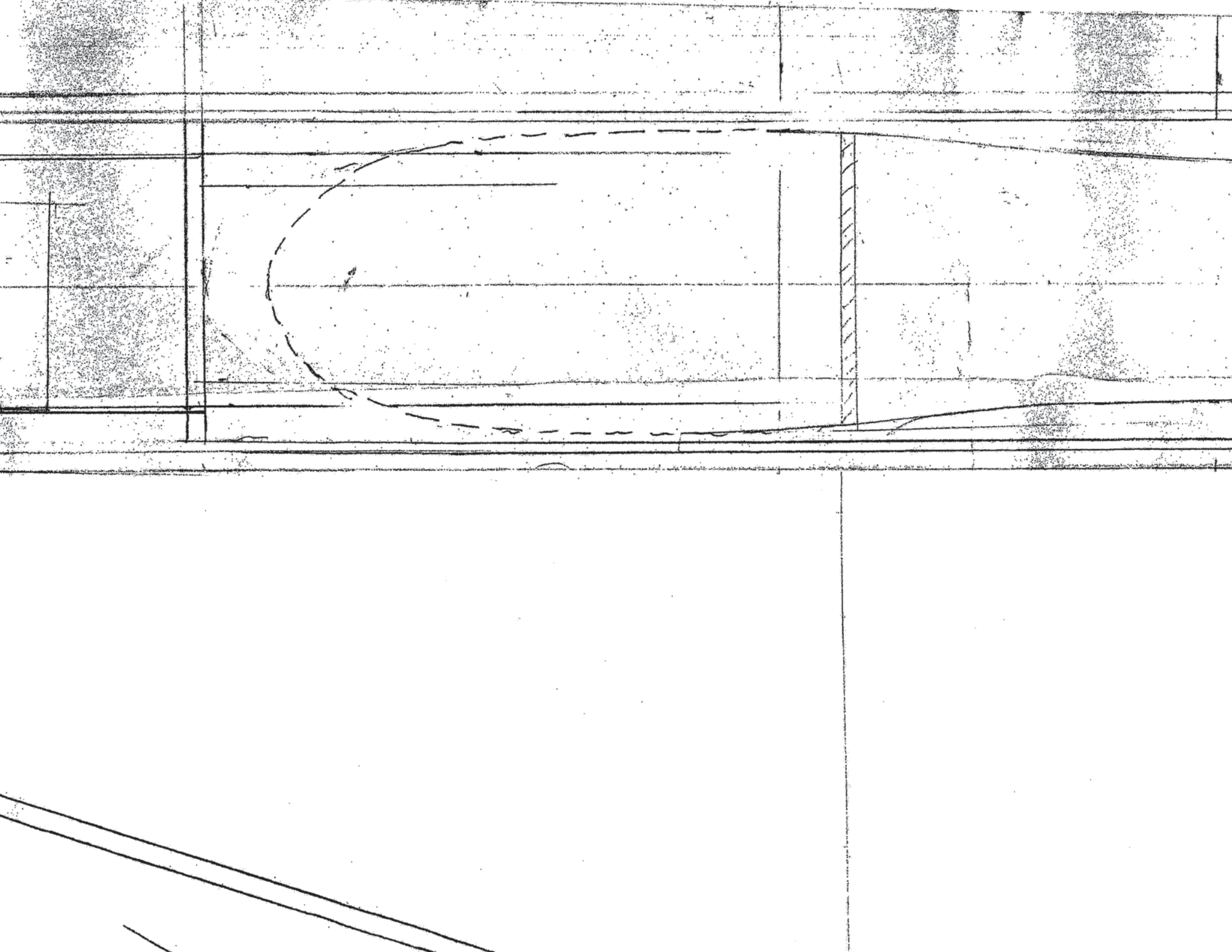

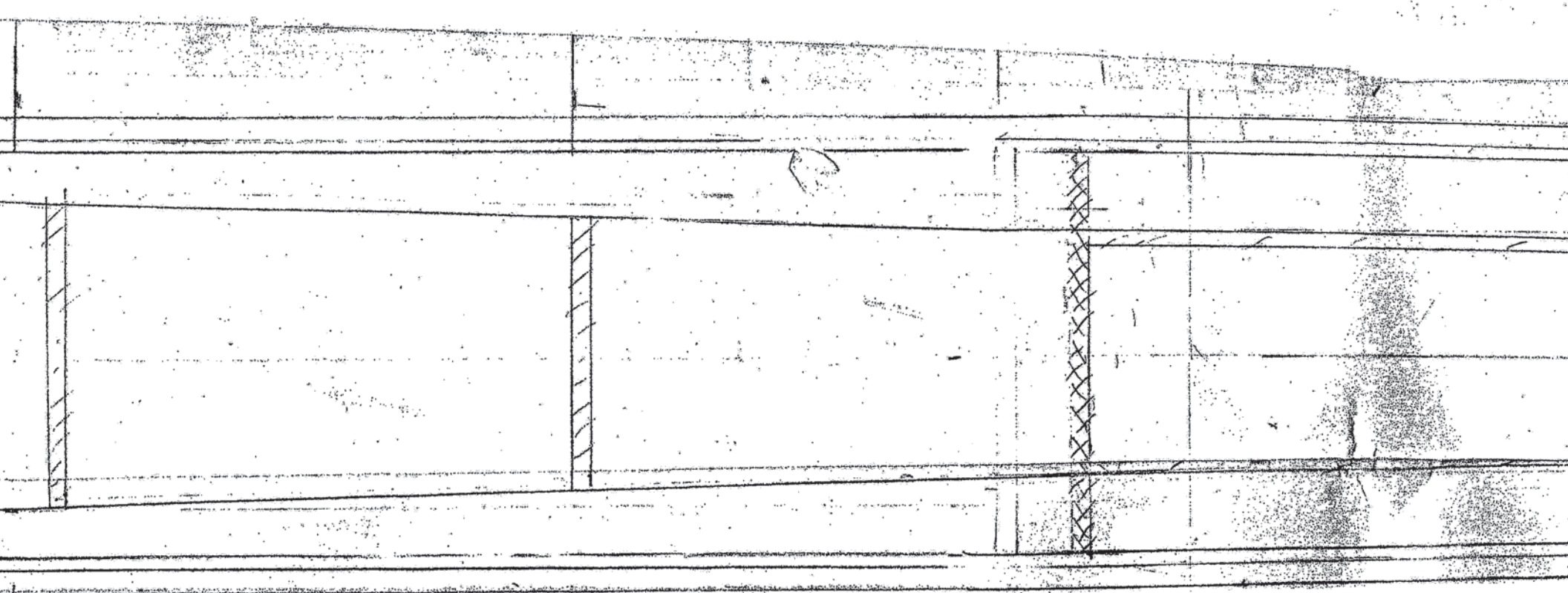

T

3/20/85

TRX 1

Pump

← Fuselage

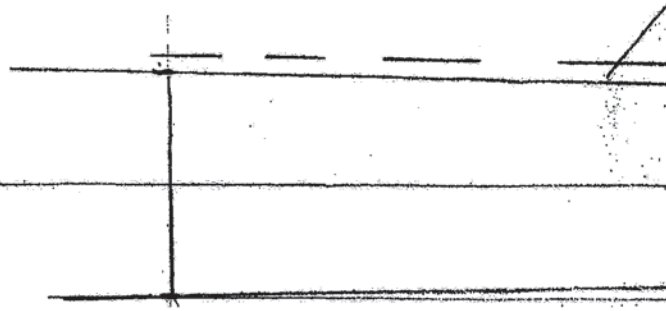
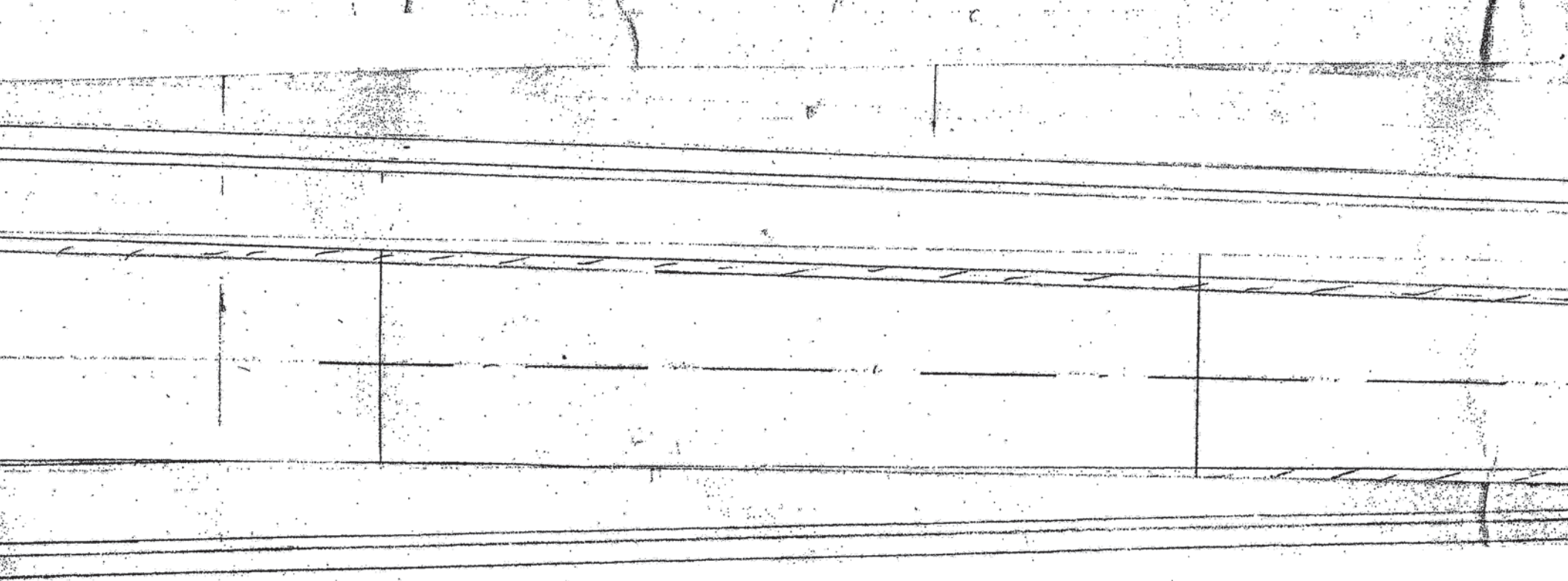

11.2 / 11.2 / 11.2 / 11.2  
Bau...

5c

**TRV**



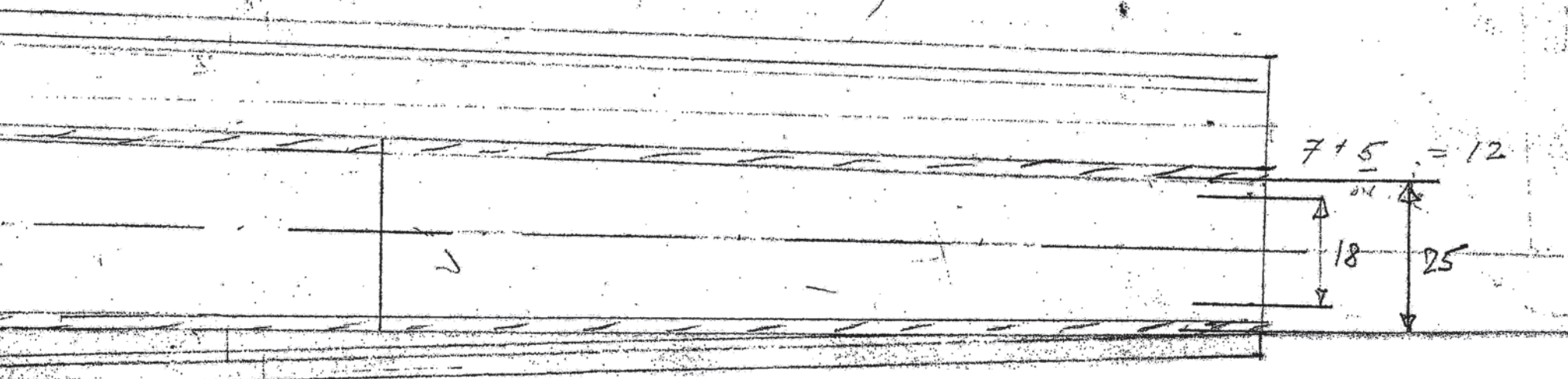

Replanting  
(sheeting)

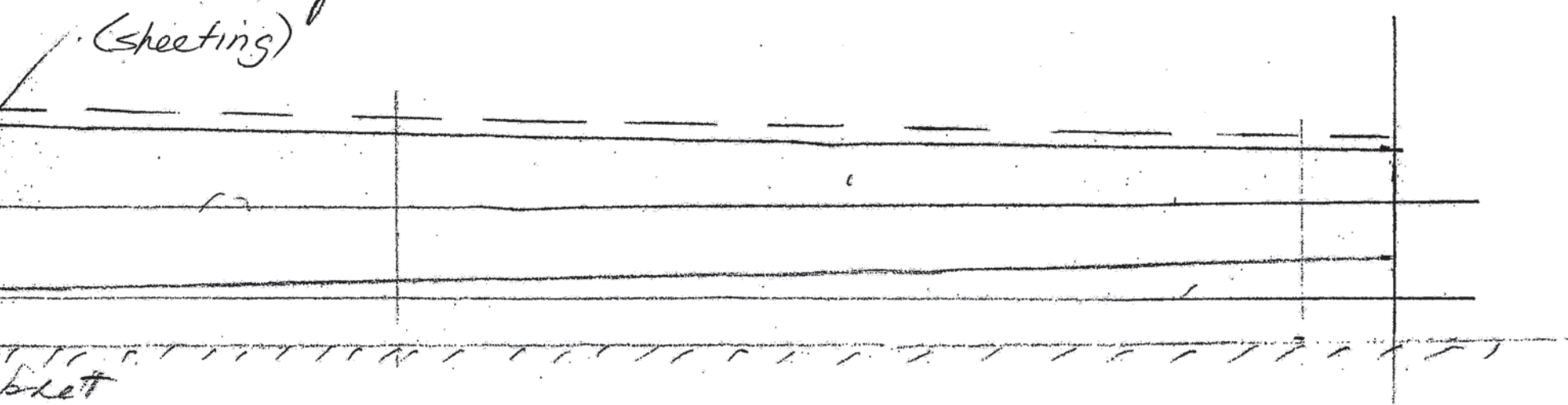

sheet

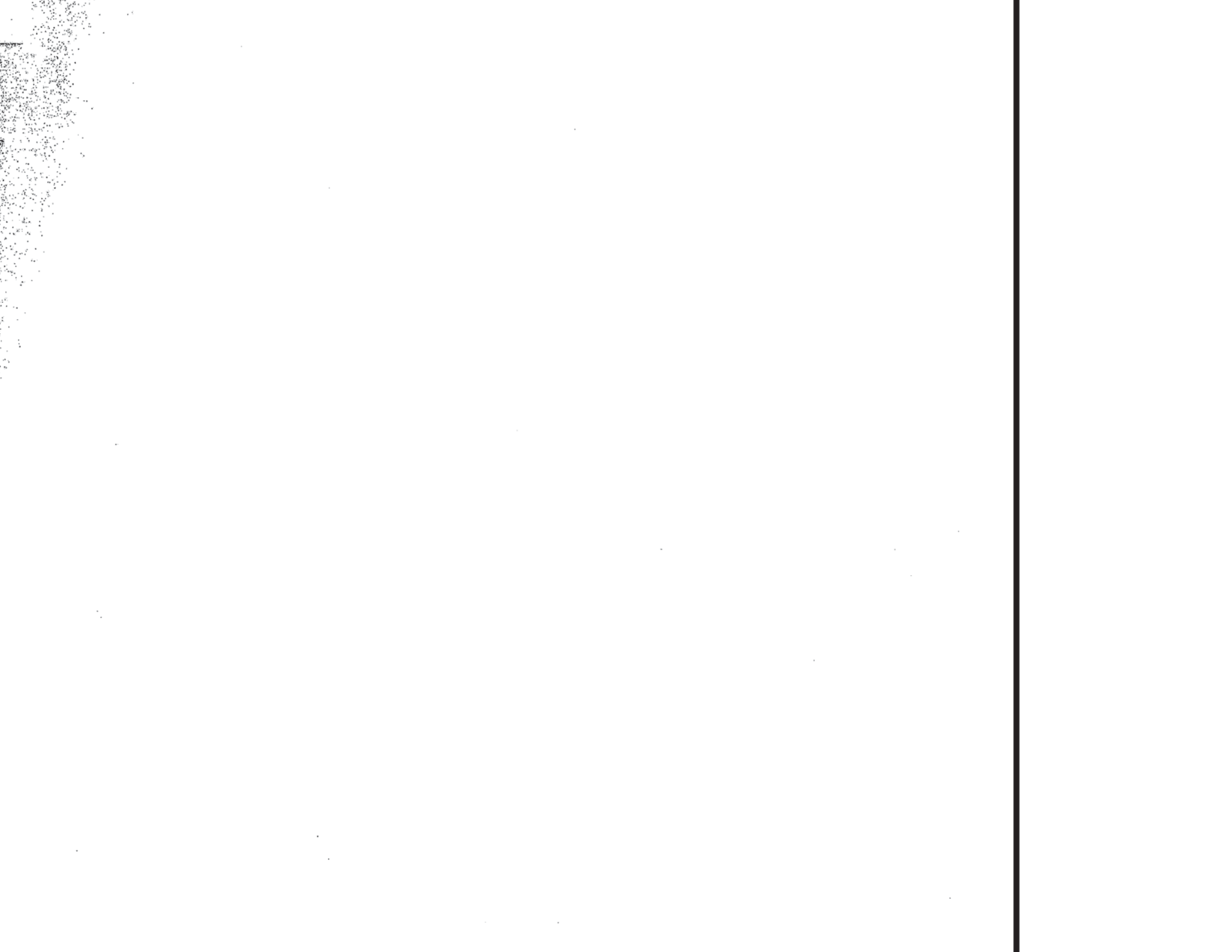



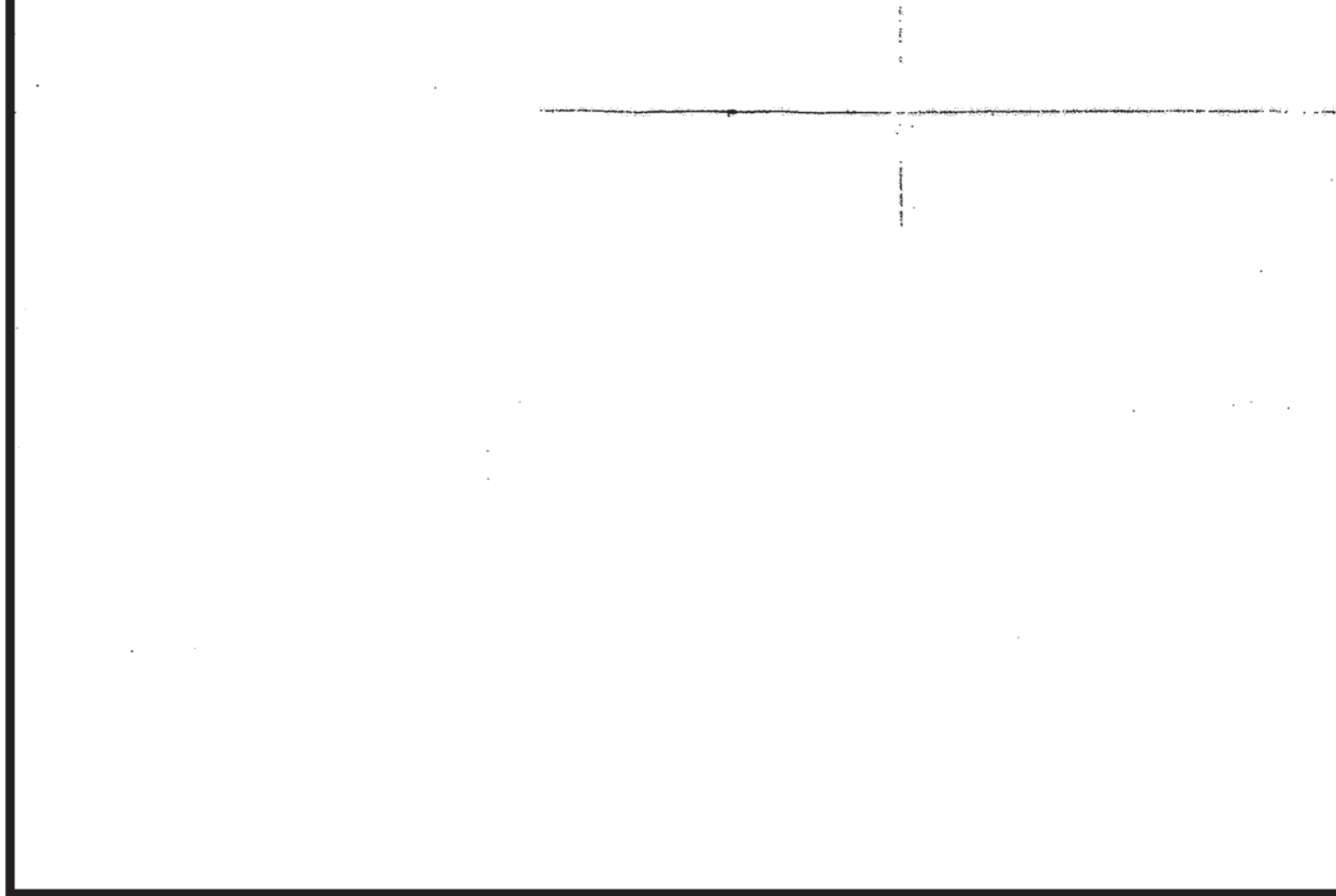

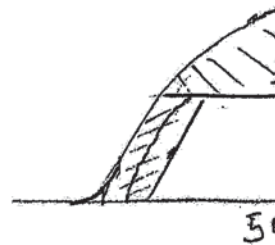
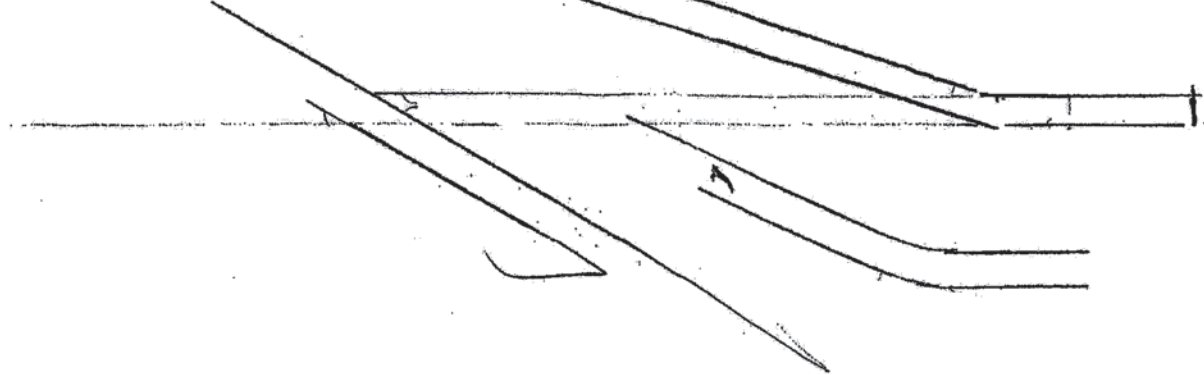

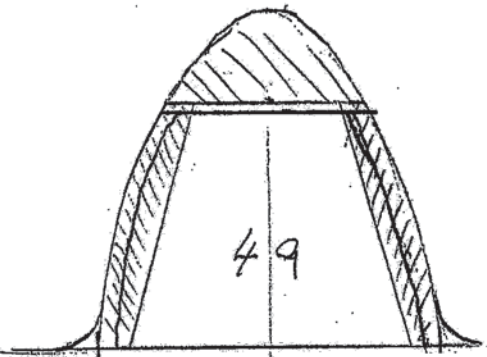
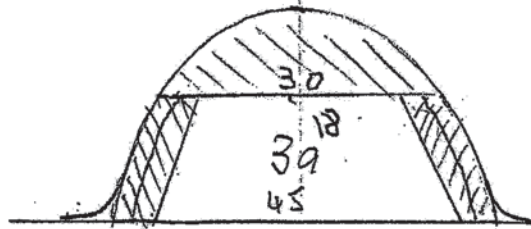

7

TBX-

DRAWN BY: GUIDO

---

**-1 SE**  
**REPLICA**  
DO PATRONCINI

TRX-1

3/2015

