

FUSE PARTS

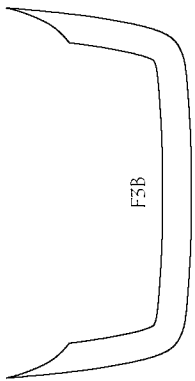

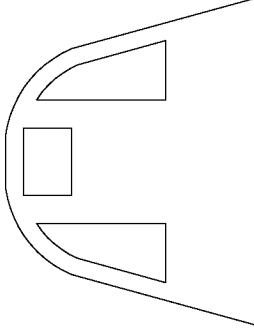
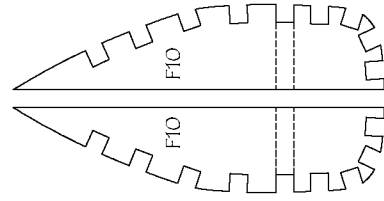
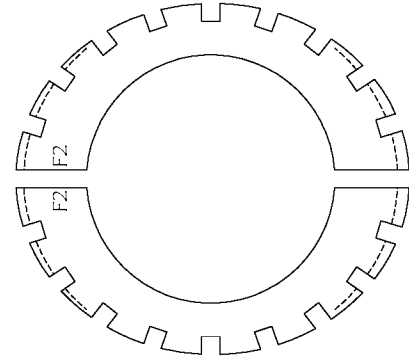
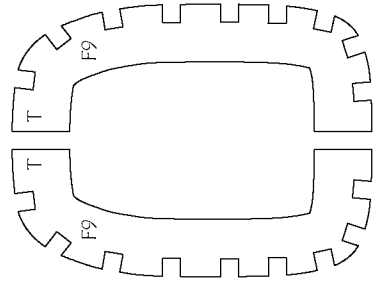
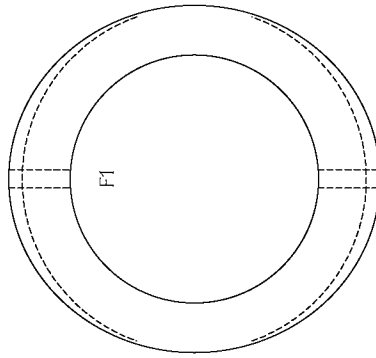

Copyright 2023 and **ModelAviation**

Copying for resale of this drawing without the written approval or consent of AMA is expressly prohibited.

3/32" Balsa

WING PARTS

LEFT WING

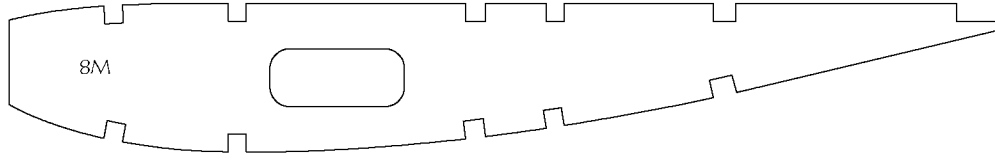

W8

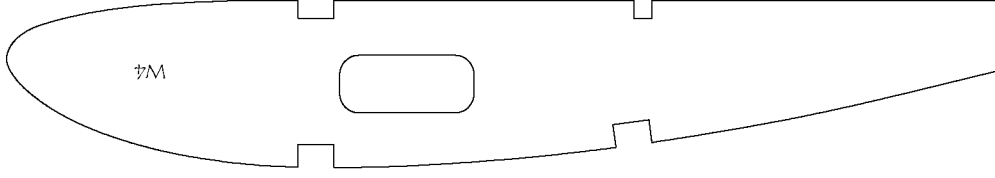

W4

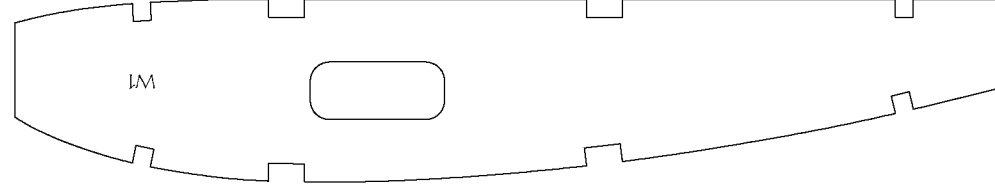

W1

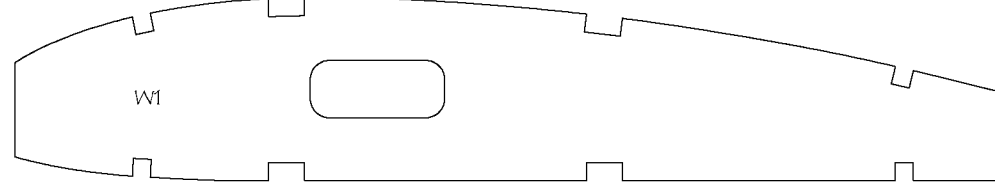

W1

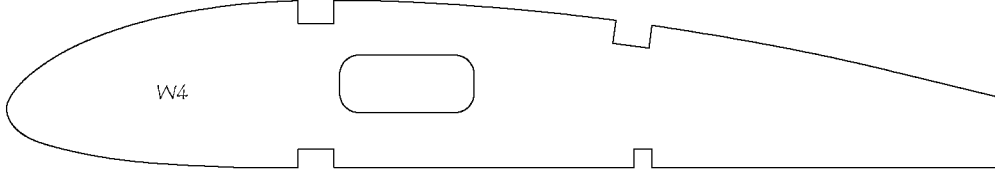

W4

RIGHT WING

F11

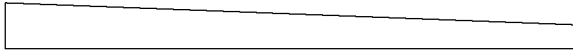

F11



SPARS FROM HARD Balsa

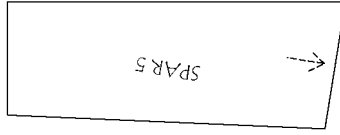

SPAR5

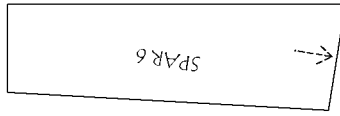

SPAR6

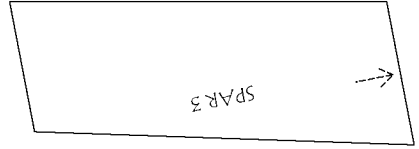

SPAR3

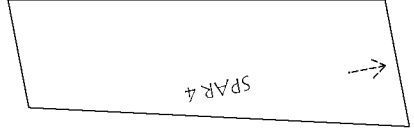

SPAR4

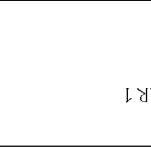

R1

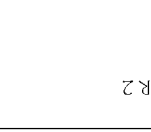

R2



TAIL PARTS

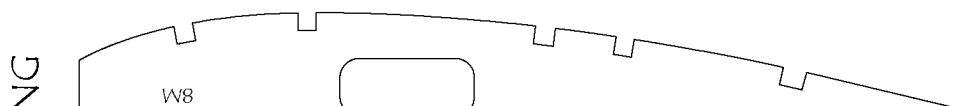
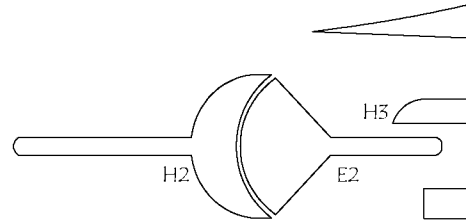
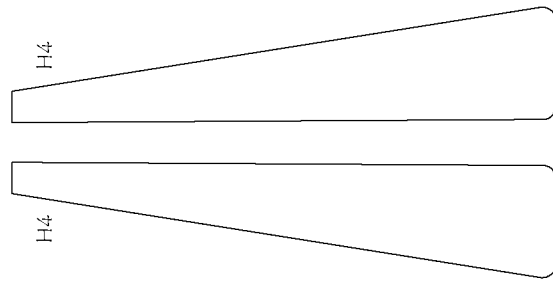
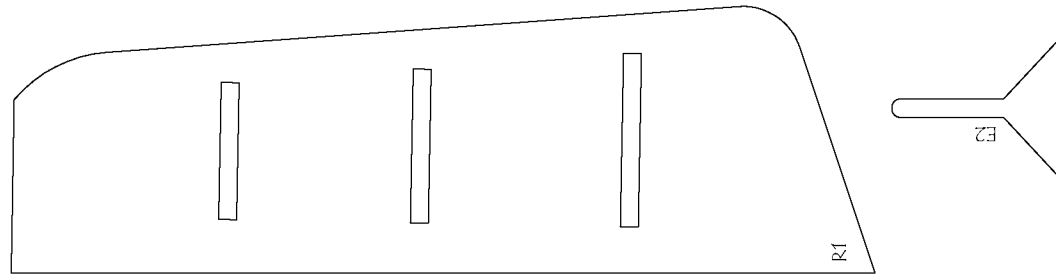
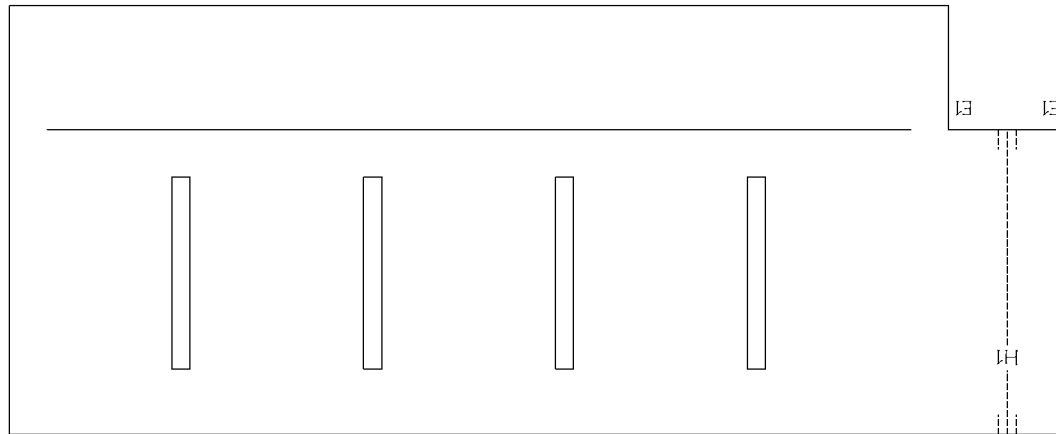
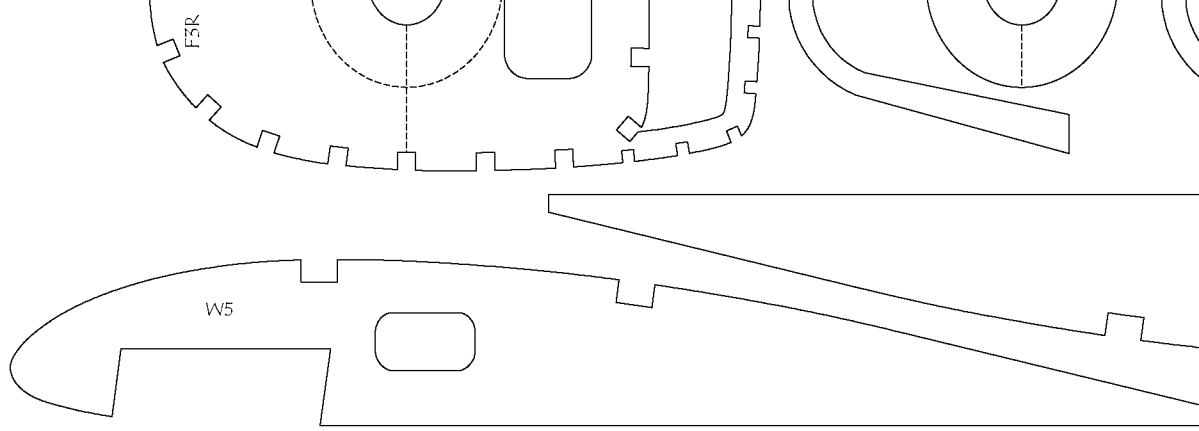

1/8" LITE PLY

GRAIN DIRECTION

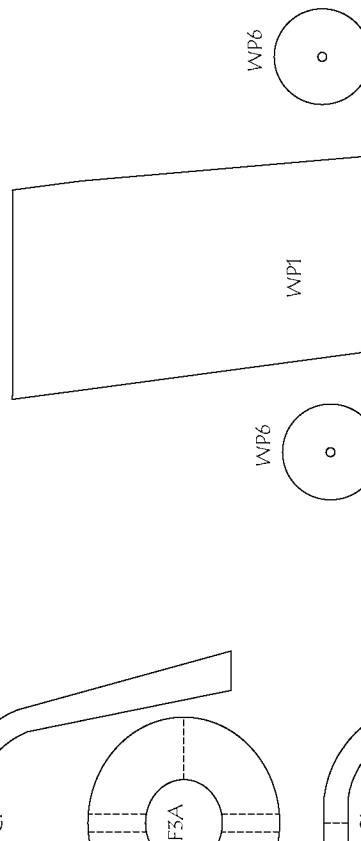
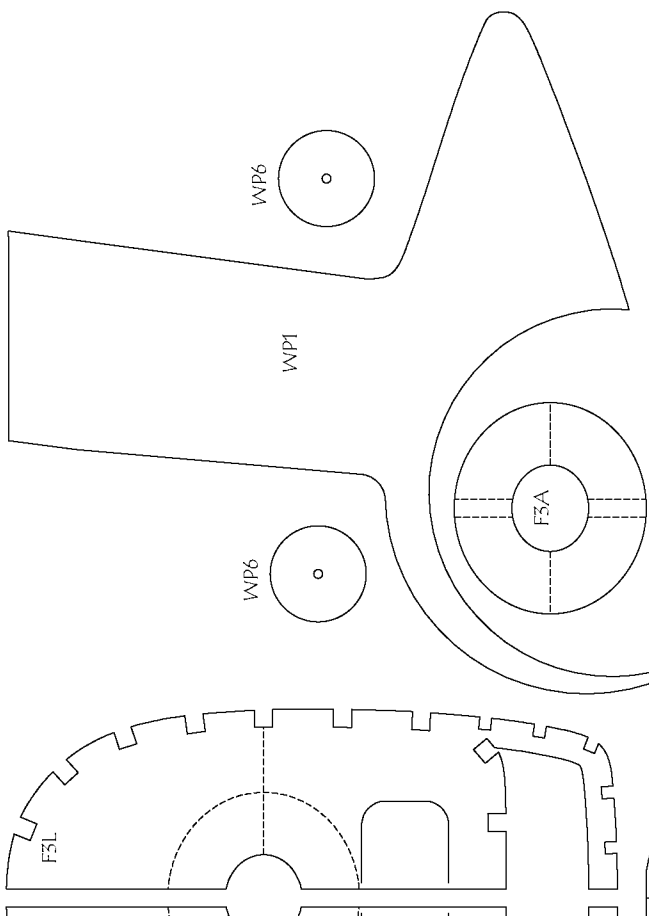

REAR OF WING

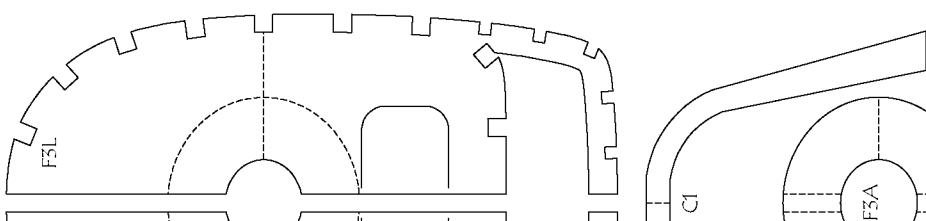

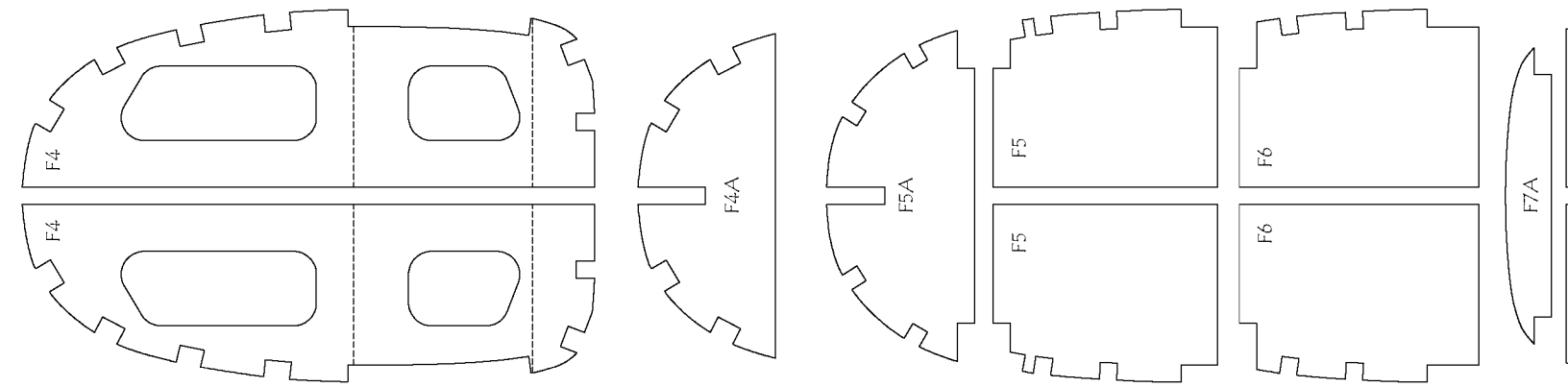
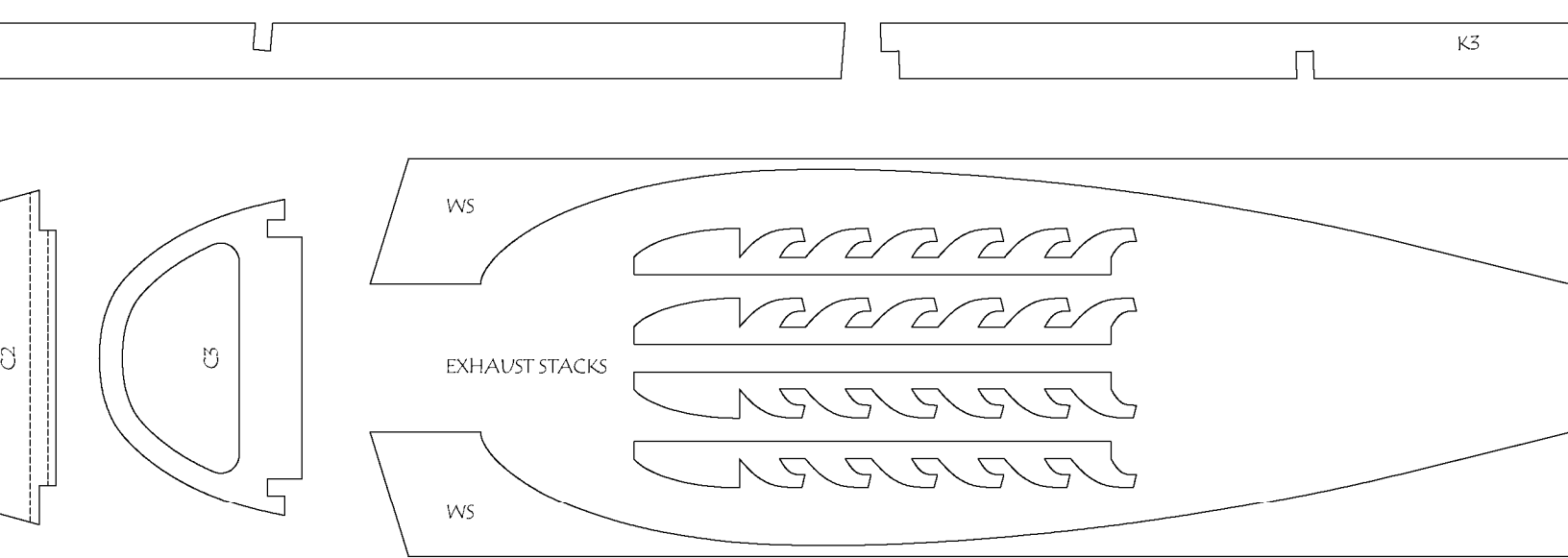

GRAIN DIRECTION

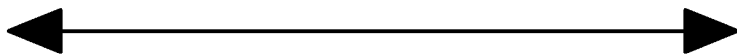

W10

W6

W2

W2

W6

W9

W10

W11

W12

SPA

SPAR4

SPAR6

SPA

SPAR3

SPAR5

K1

K7

K2

K8

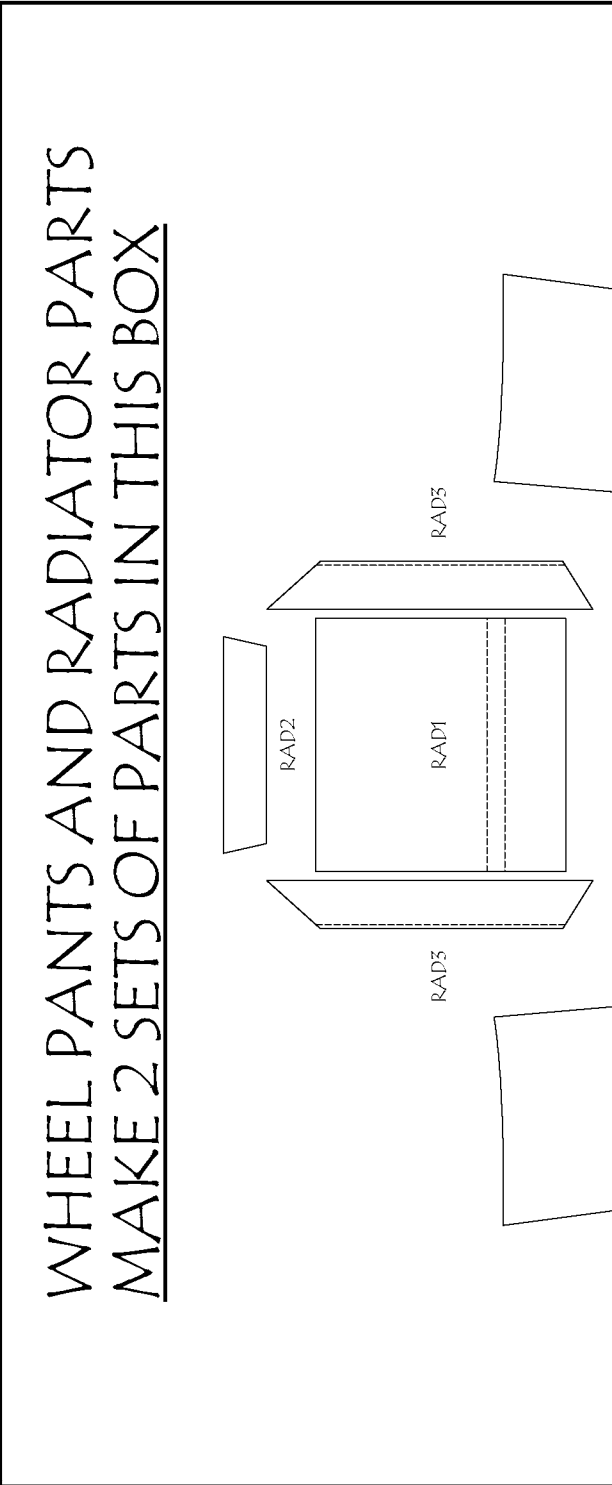
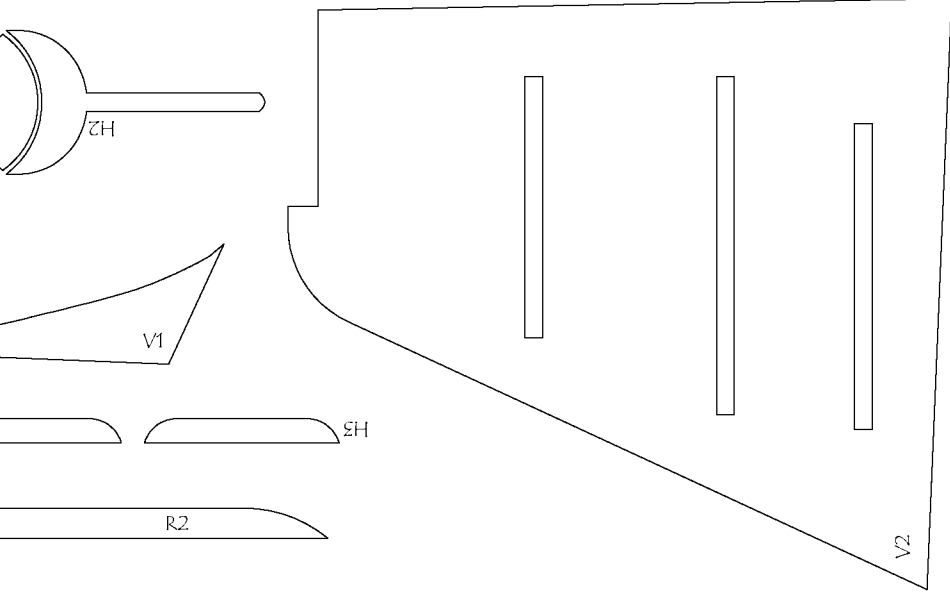
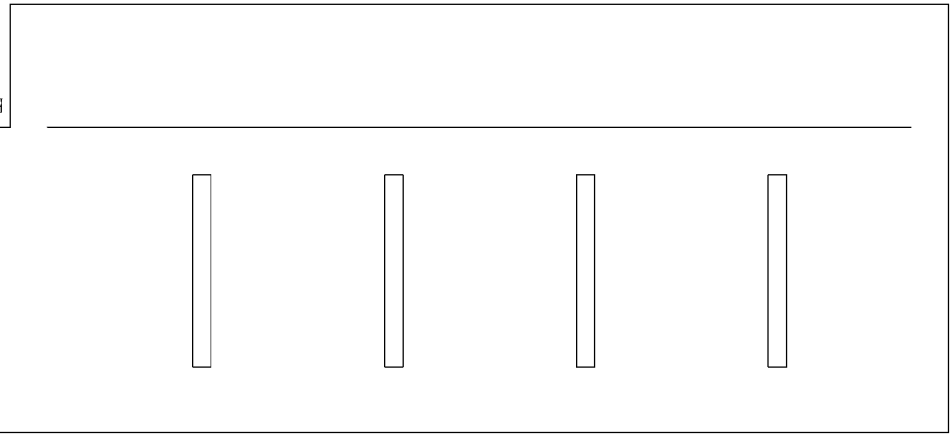
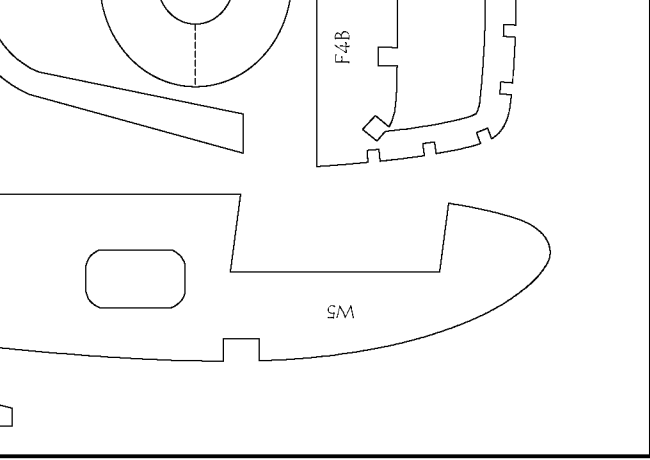

**WHEEL PANTS AND RADIATOR PARTS
MAKE 2 SETS OF PARTS IN THIS BOX**

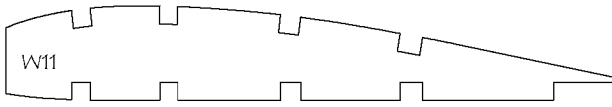
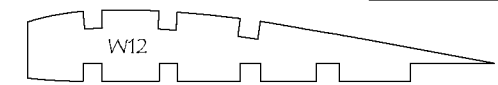

STRINGER #1	STRINGER #1	STRINGER #1	CENTER SECTION DIHEDRAL JIG BUILDING BOARD
-------------	-------------	-------------	---

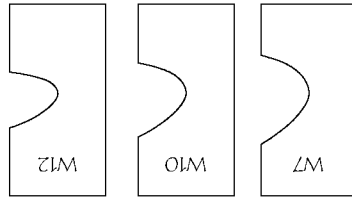

WINDOW TEMPLATES

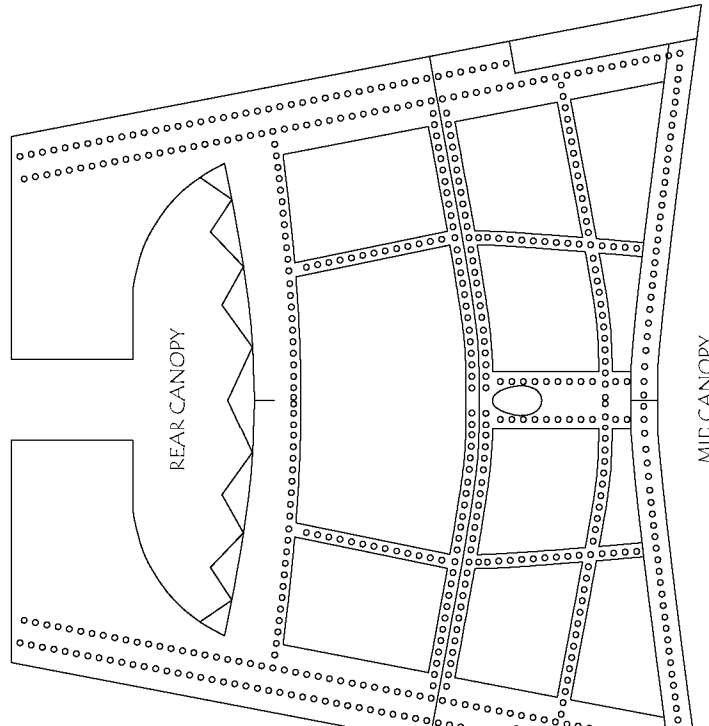

TEMPLATES

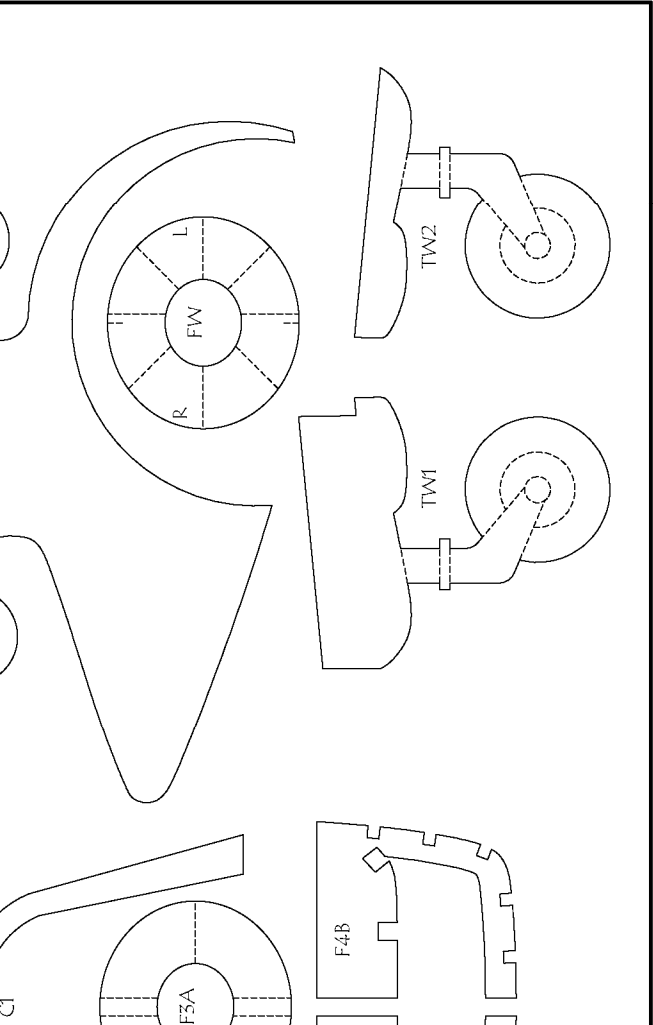
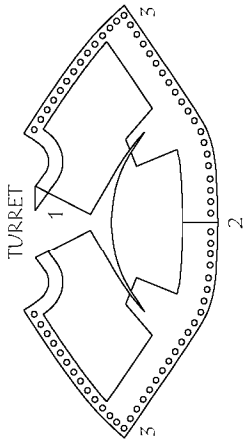

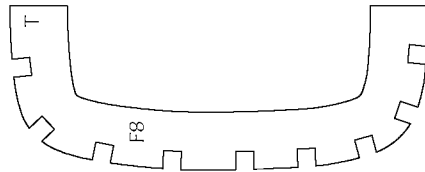
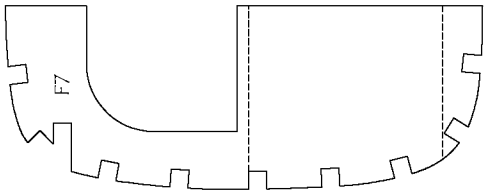
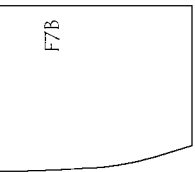
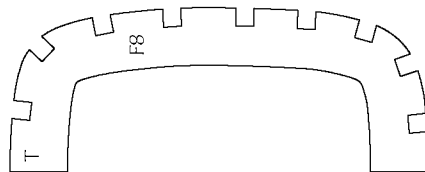
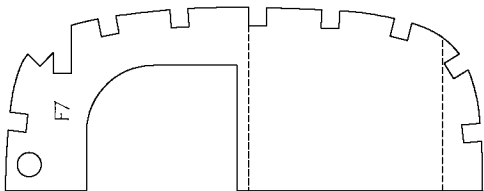
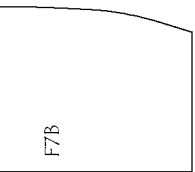
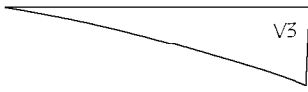
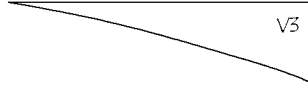
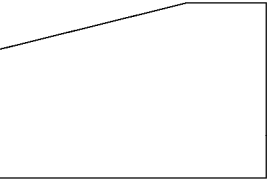
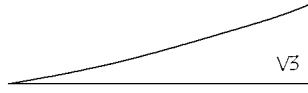
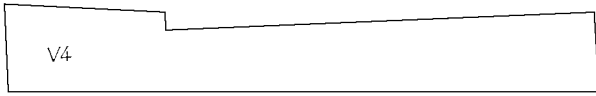
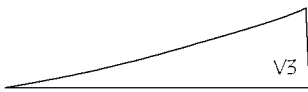
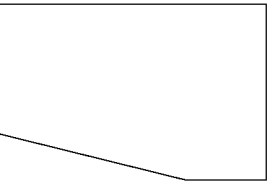
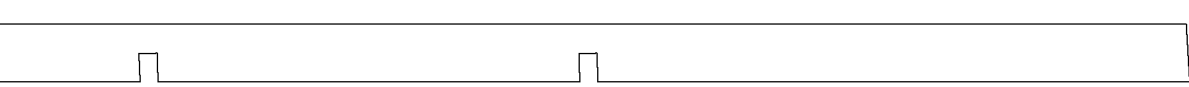

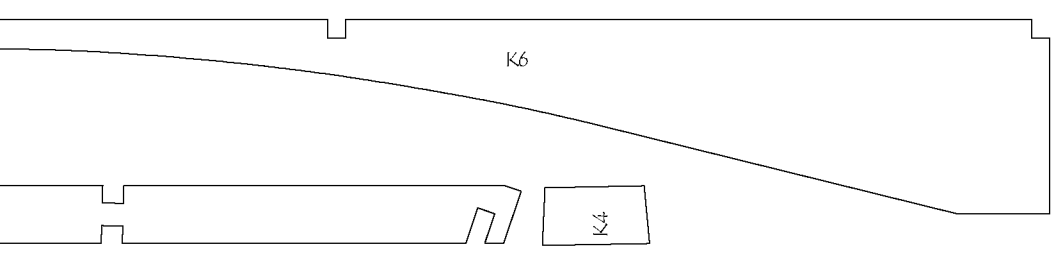
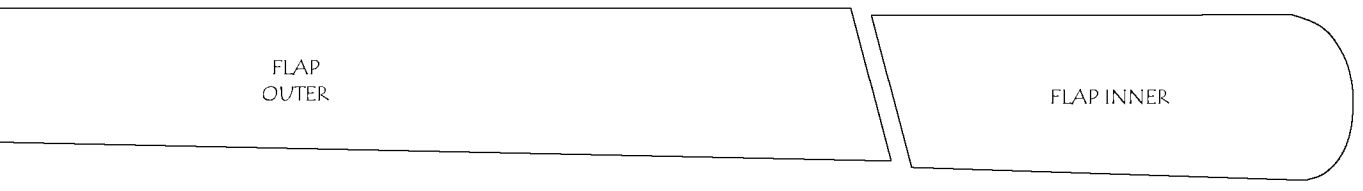
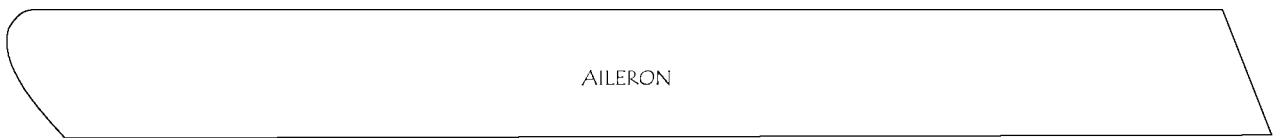
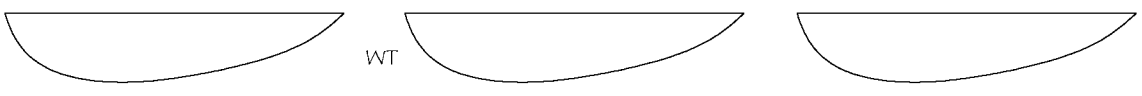
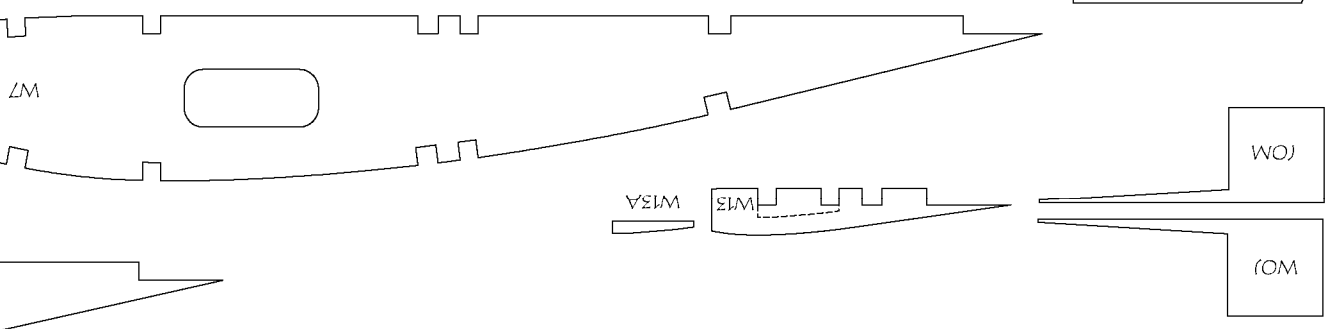
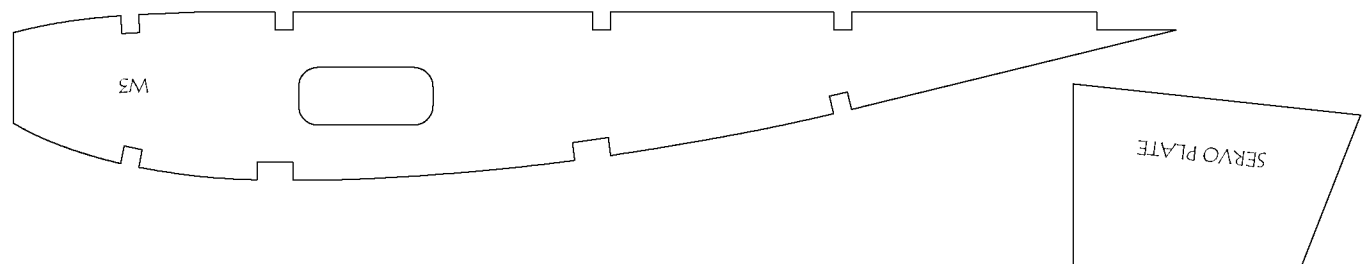
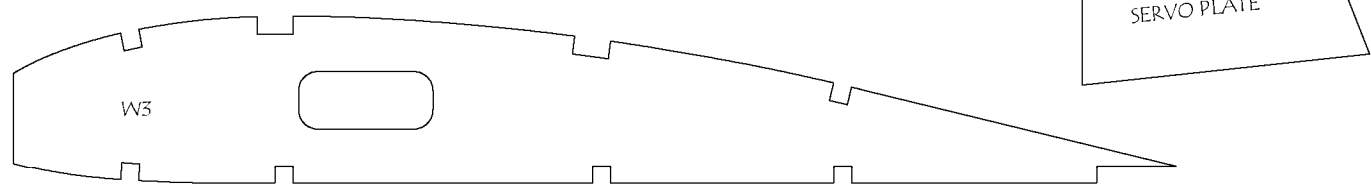
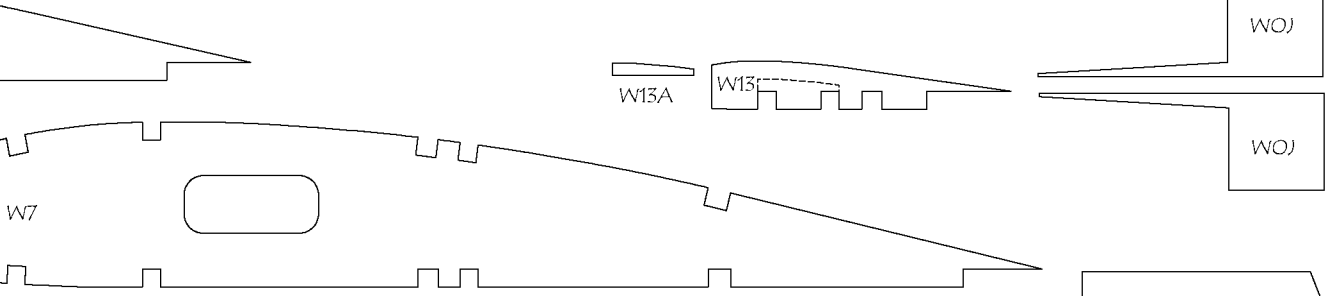

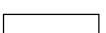
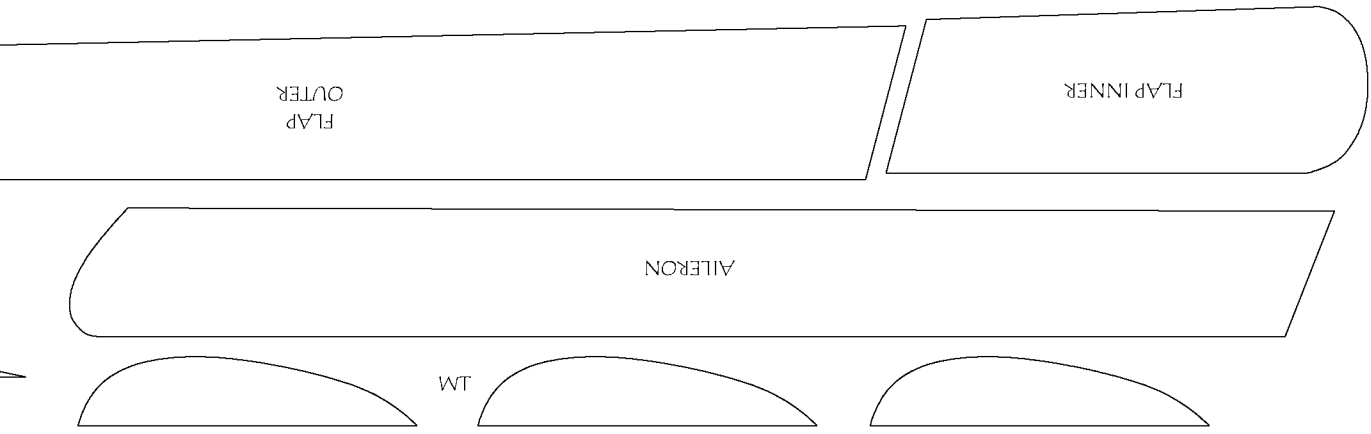
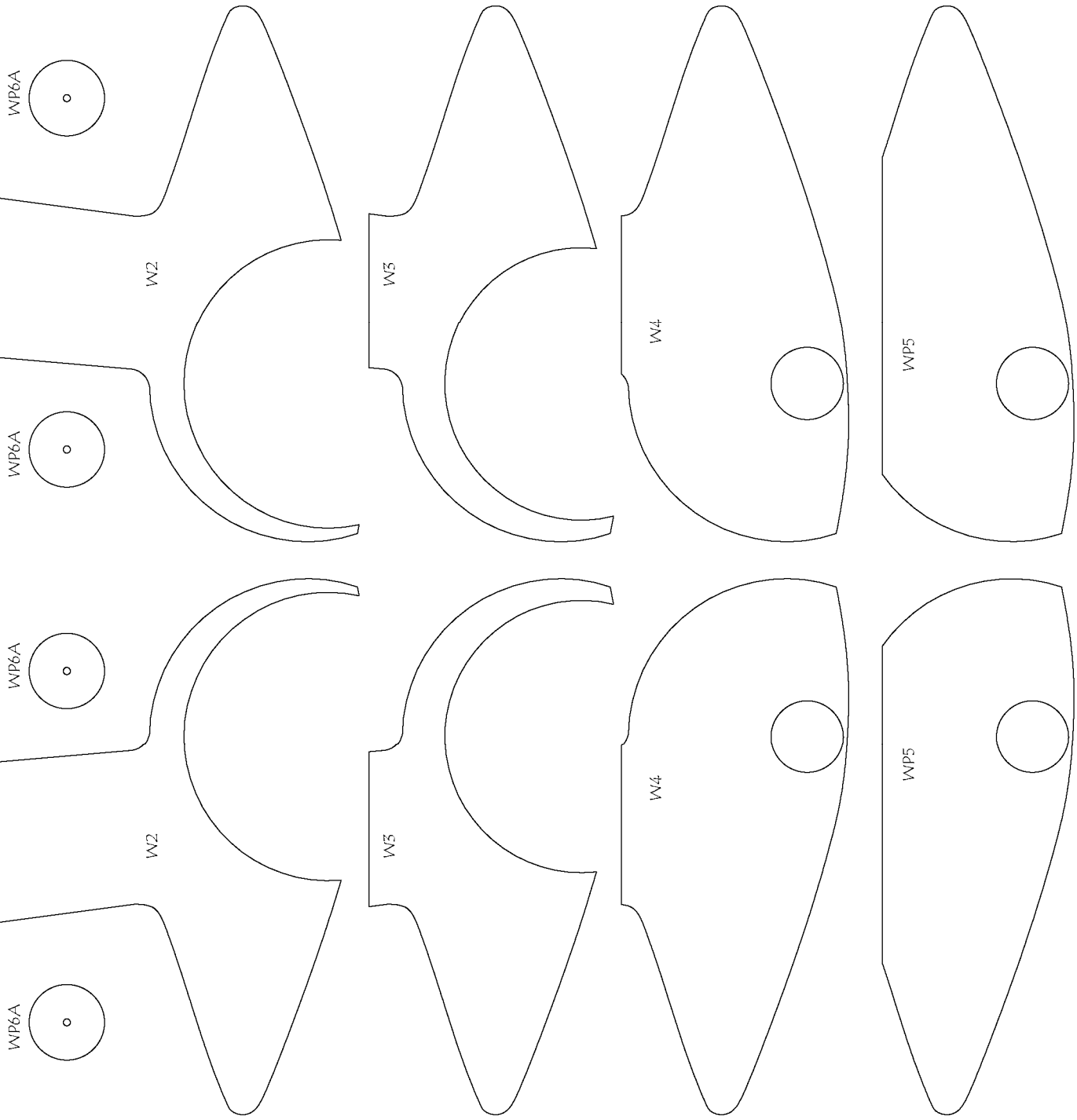
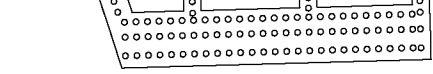

CENTER SECTION DIHEDRAL JIG	REAR OF WING
-----------------------------	--------------

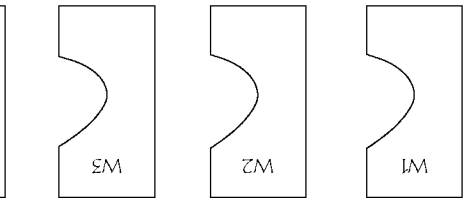

WING LEADING EDGE

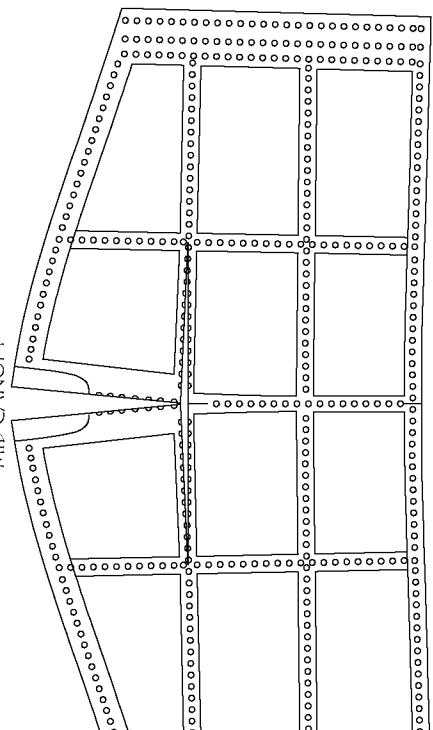

FRONT CANOPY

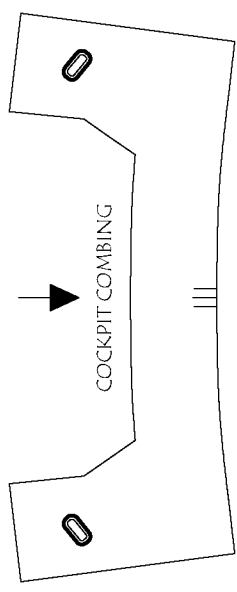
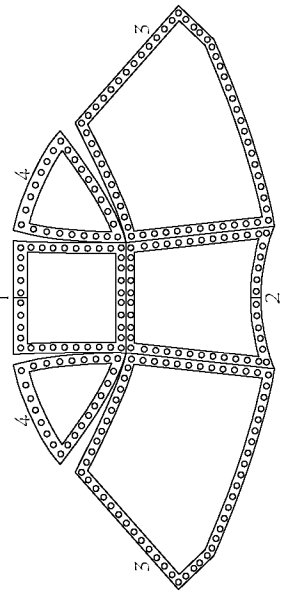

JU-87 D3 STUKA PARTS SHEET

DESIGNED BY DEREK MICKO
30" WINGSPAN
ALL RIGHTS RESERVED

Sheet 3 of 3 Plans No. 1137

1	2	3	4	5	6
---	---	---	---	---	---