

ASM2 x

ASM1 x

F1R

FSM1 x 2

F1L

A6 x 2

R8A x 2

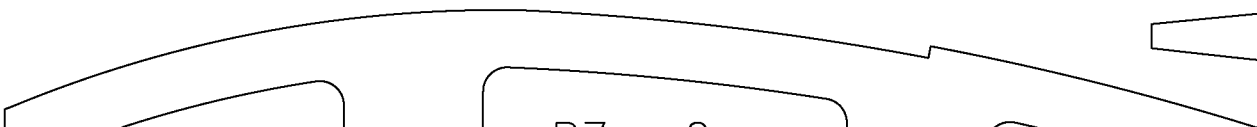

2

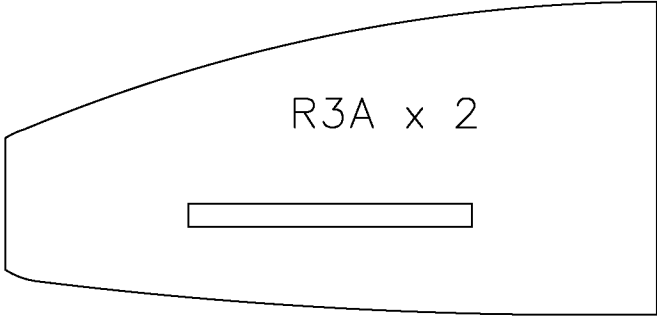
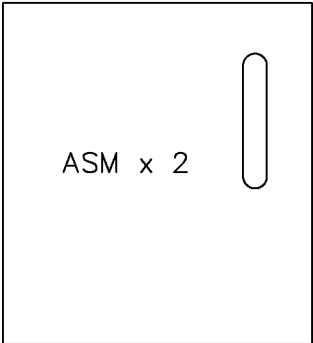

2

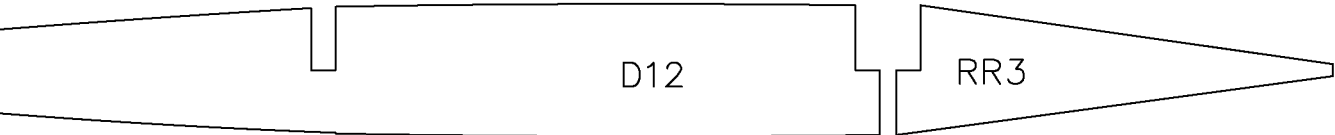
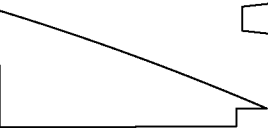
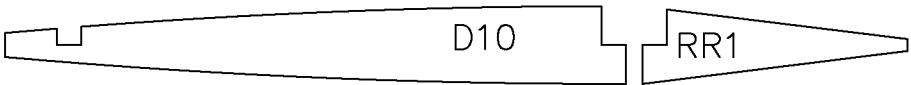
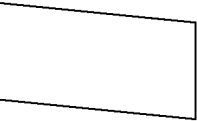
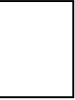
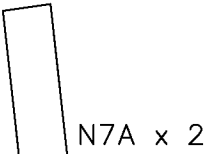
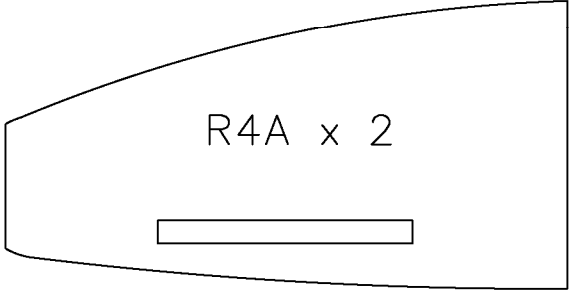
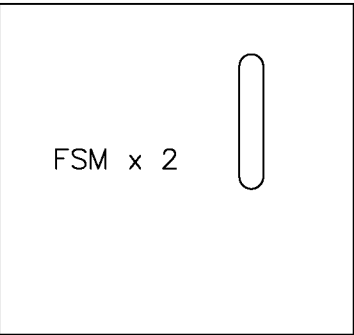

N7Ar x 2

← Grain Direction →

N7 x 2

N7r x 2

N6A x 2

N6 x 2

N11A x 4

N11 x 4

N8 x 2

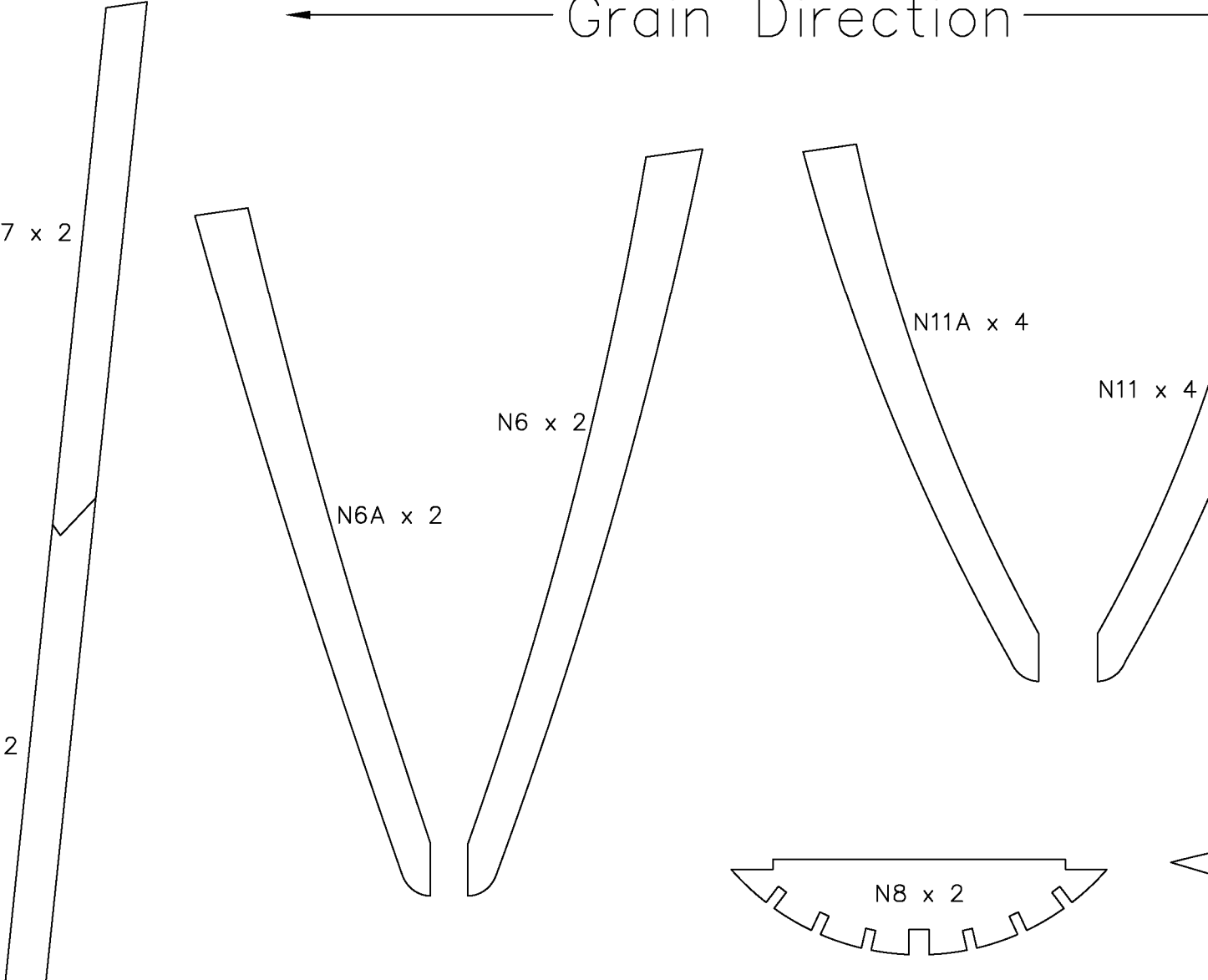

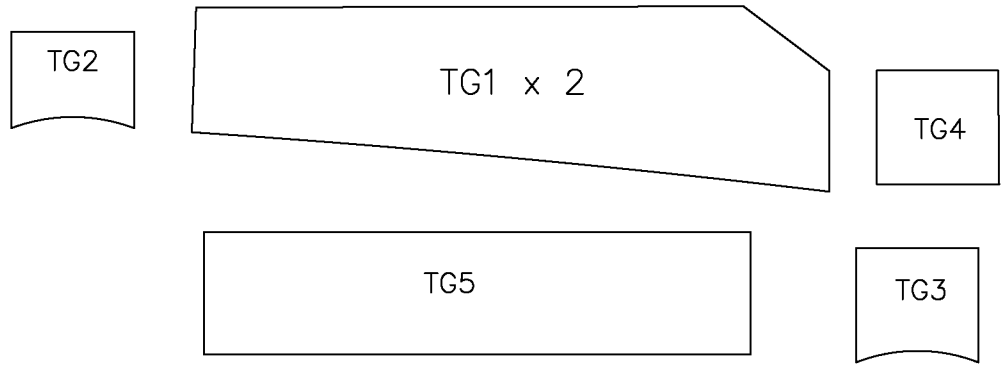
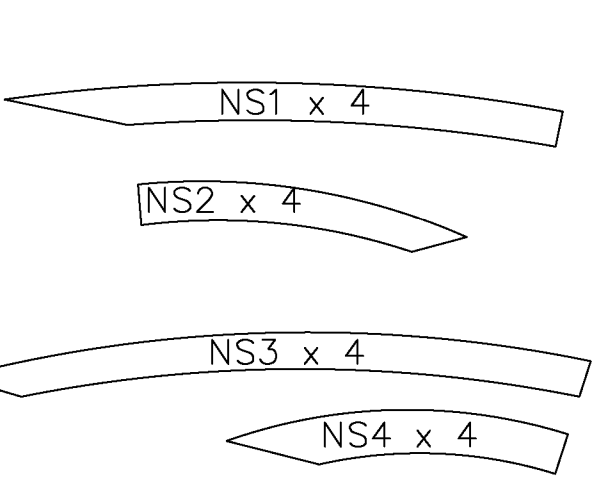
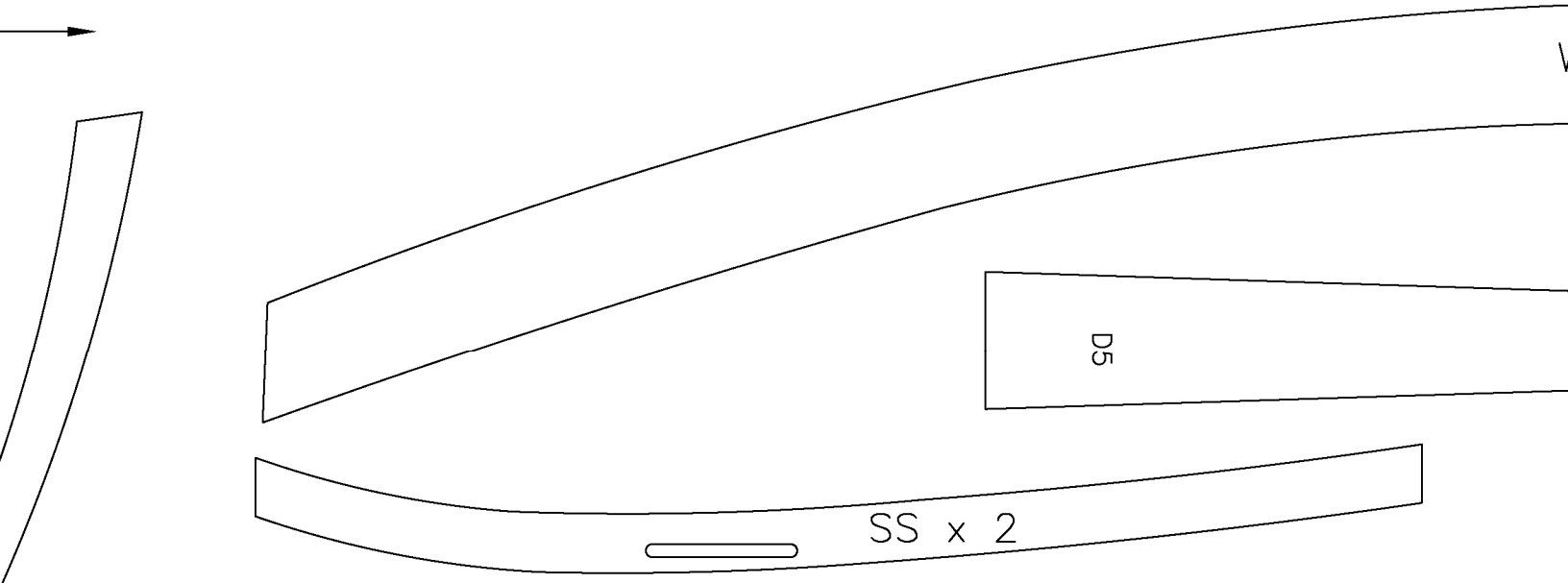

WS x 2

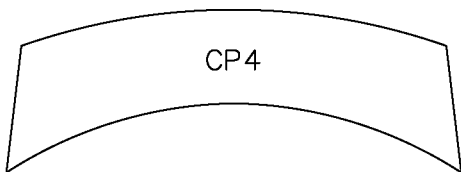
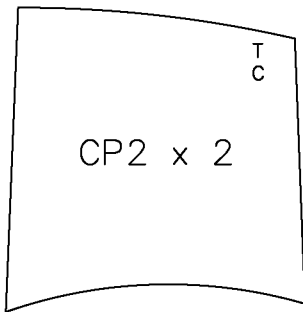
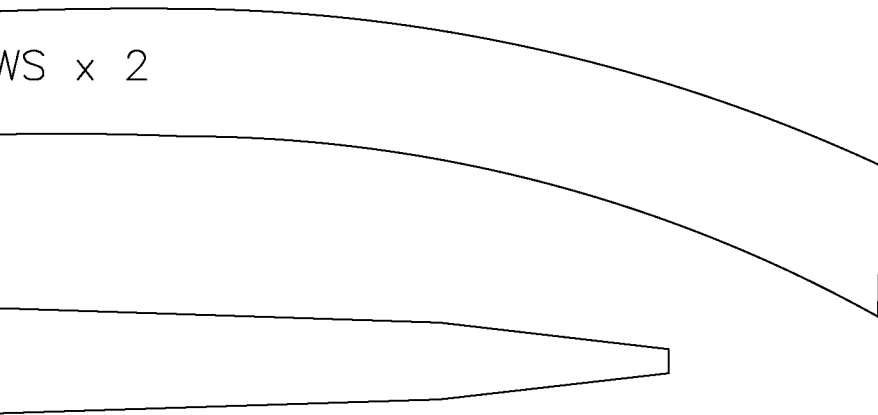

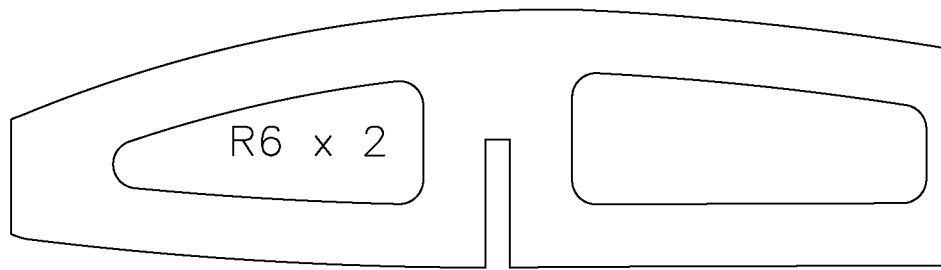
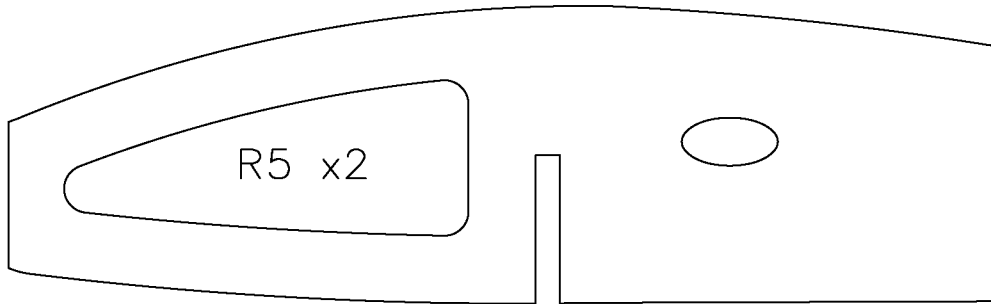
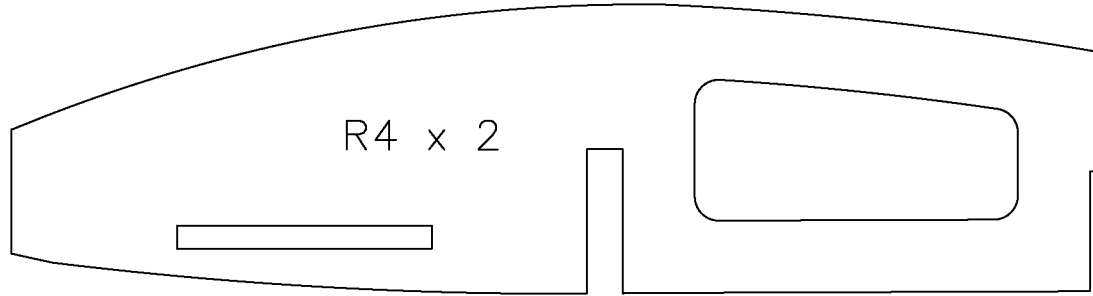
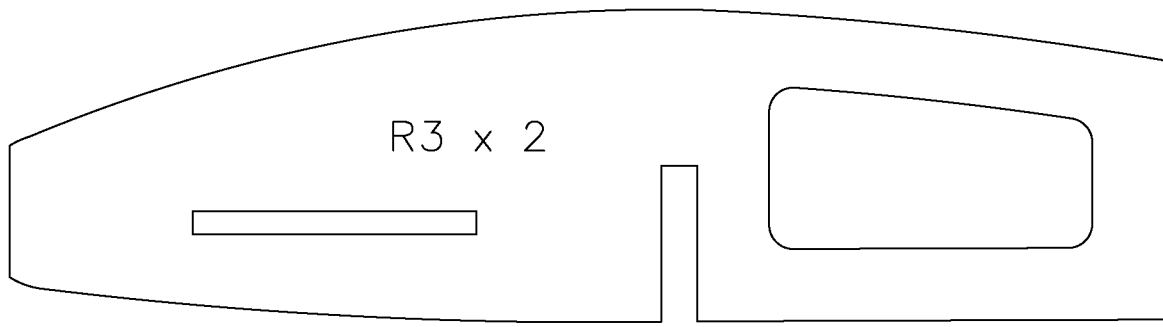

1/8 Balsa

WG x 4

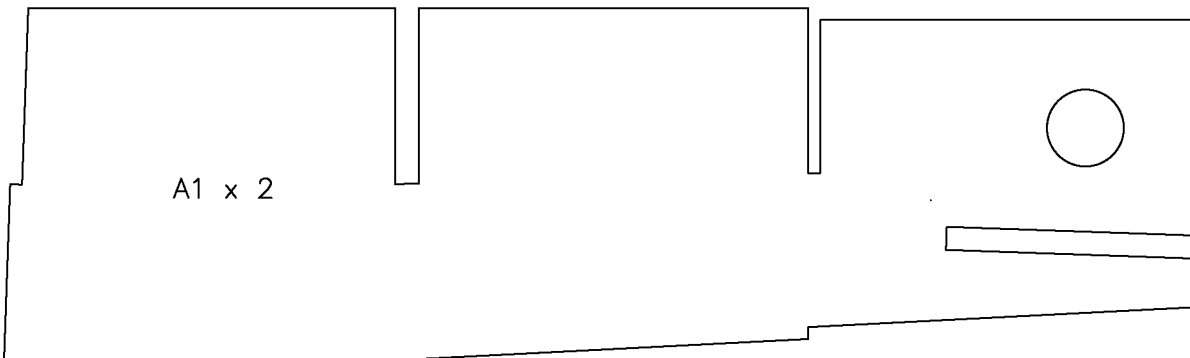
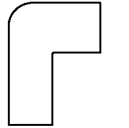

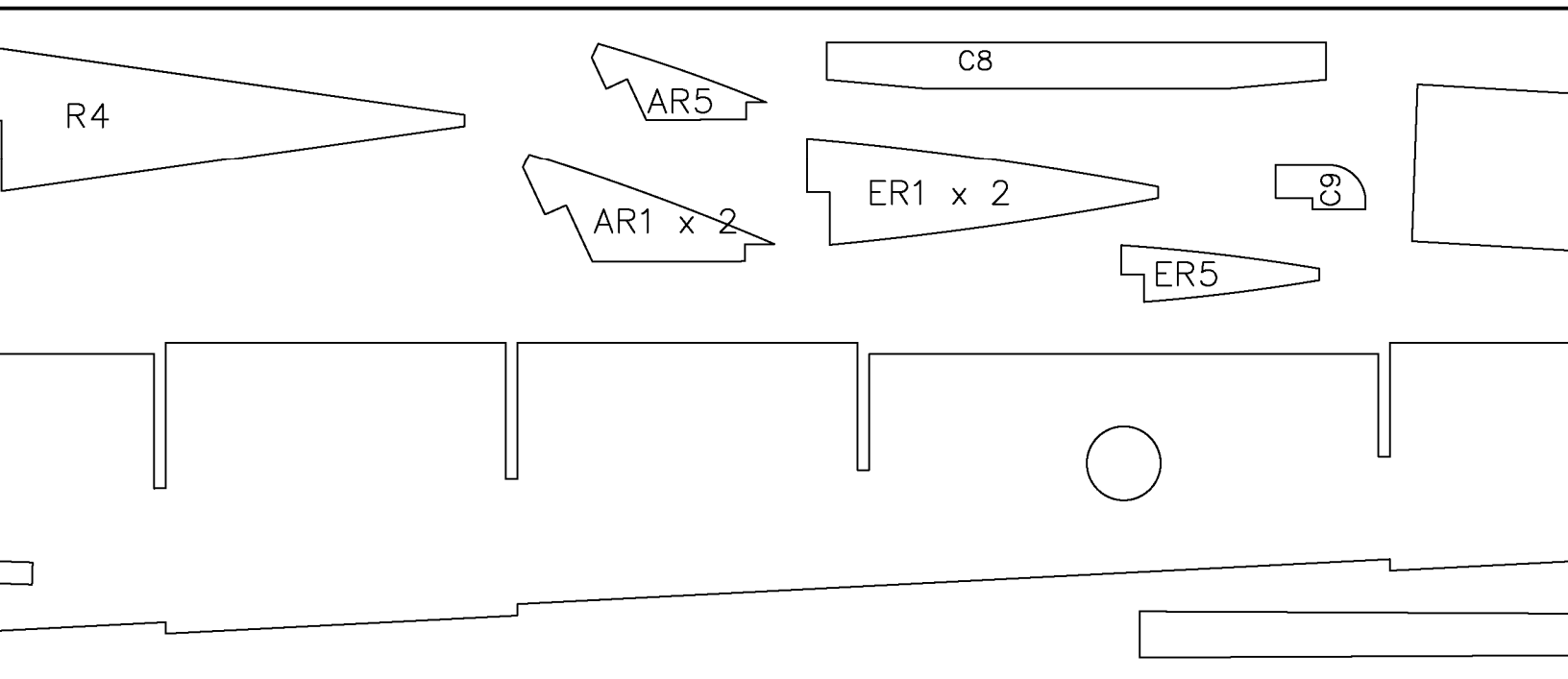
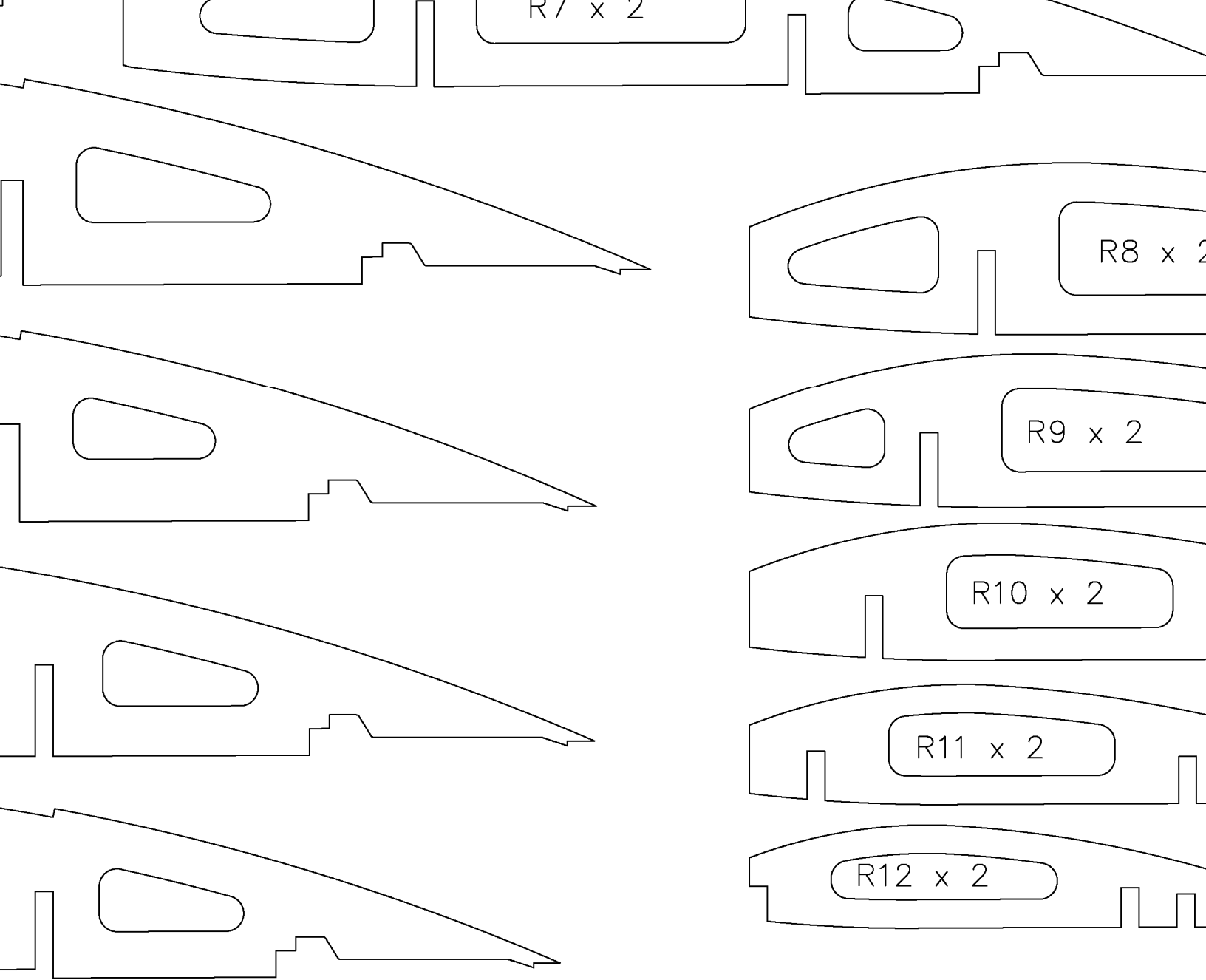



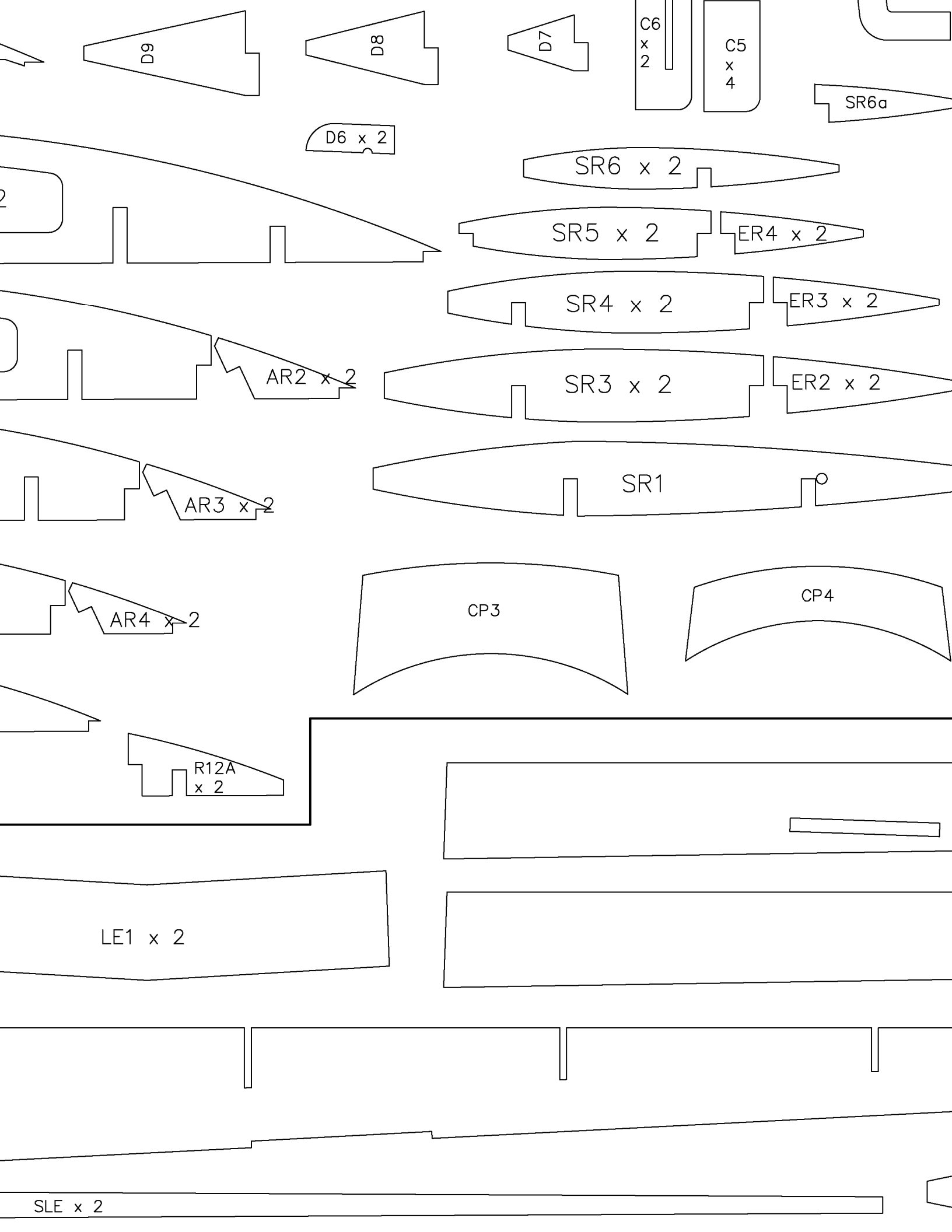

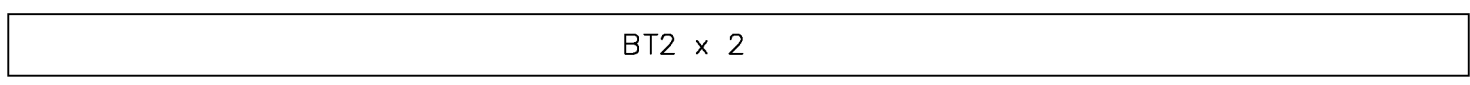
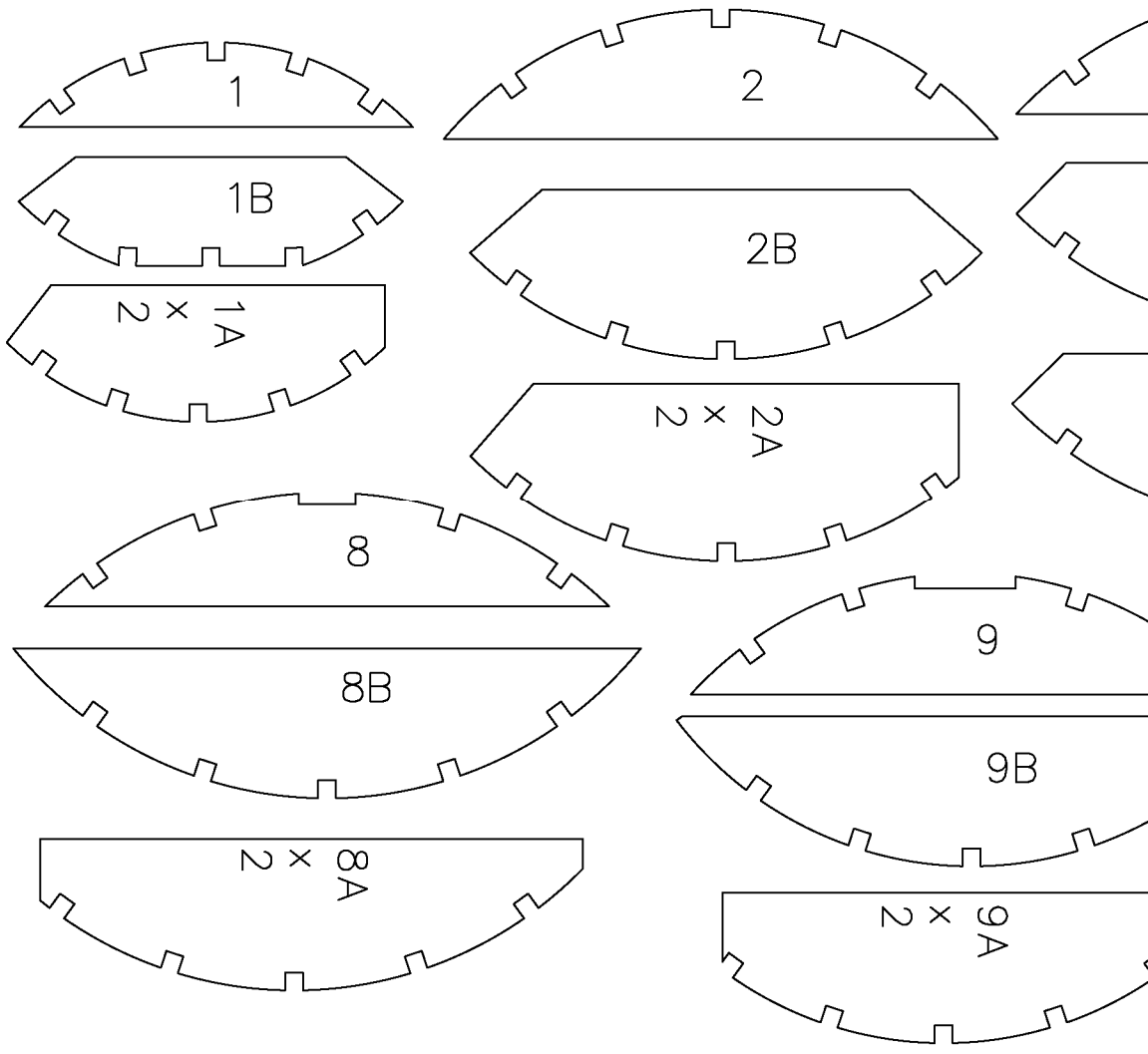

LE2A x 2

LE2 x 2

A1C

SR2 x 2

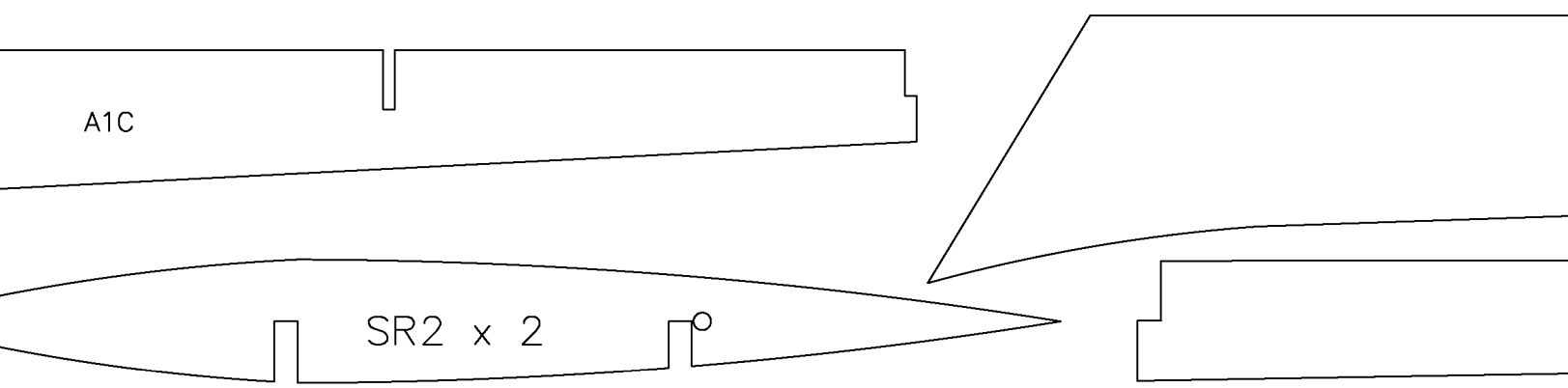

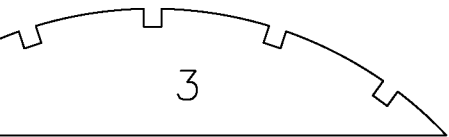

3

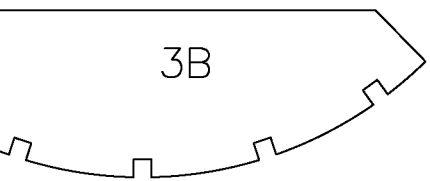

3B

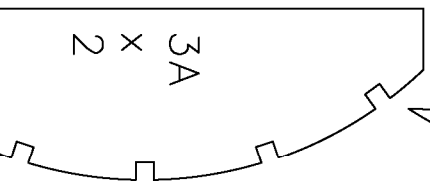

3A  
2 x 2

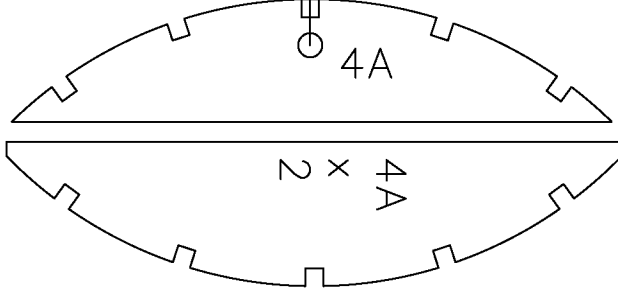

4A

4A  
2 x 2

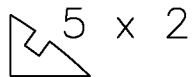

5 x 2

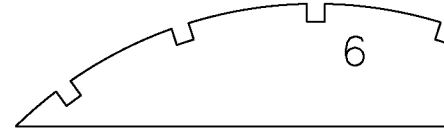

6

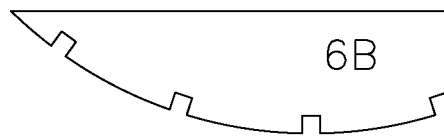

6B

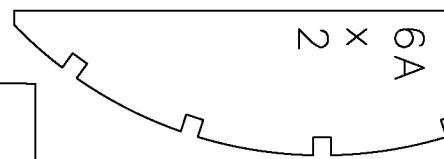

6A  
2 x 2

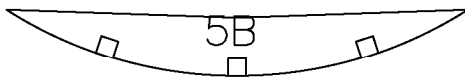

5B

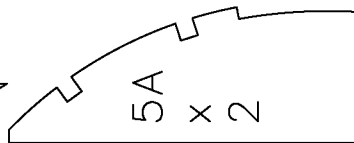

5A  
x 2



6B

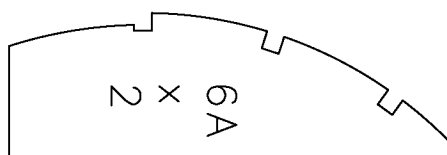

6A  
2 x 2



11

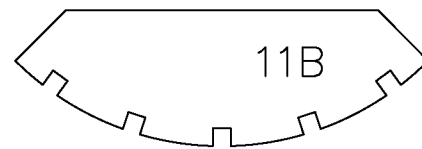

11B

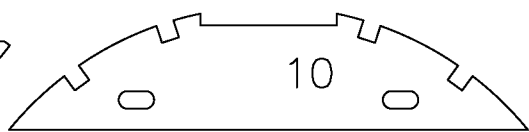

10

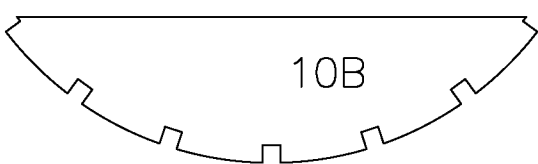

10B

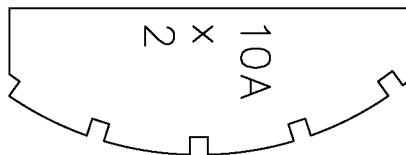

10A  
2 x 2

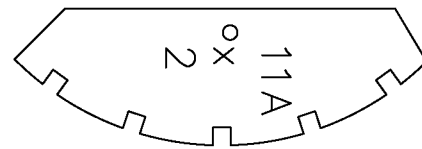

11A  
2 x 2

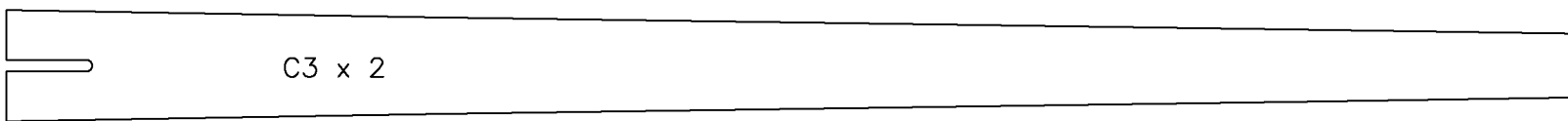

C3 x 2

CP1 x 2

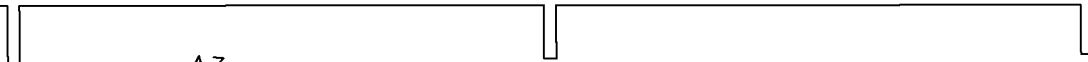

A3 x 2

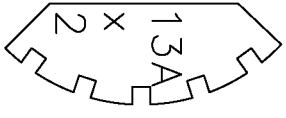
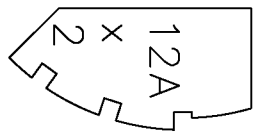
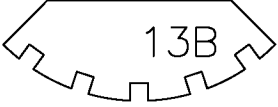
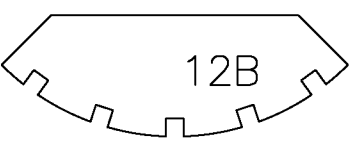
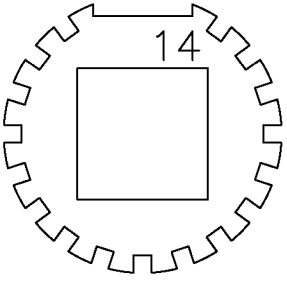
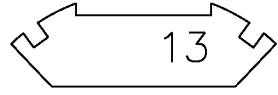
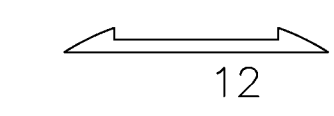
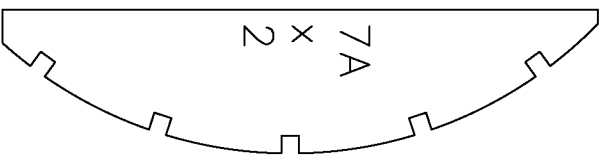
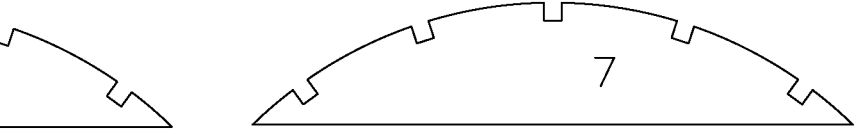

1/16 Balsa

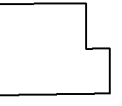
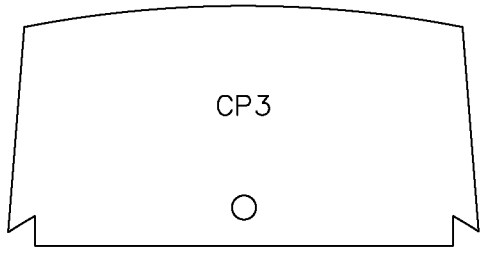
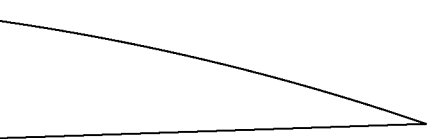
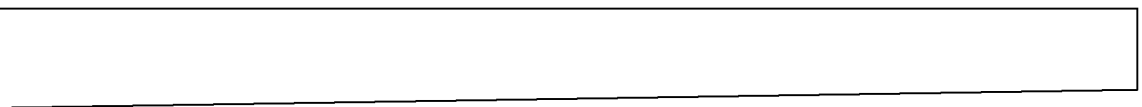

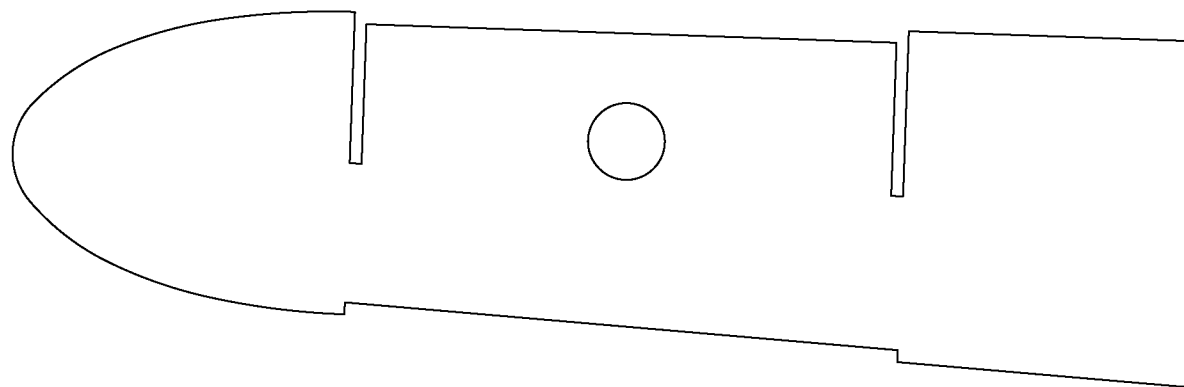
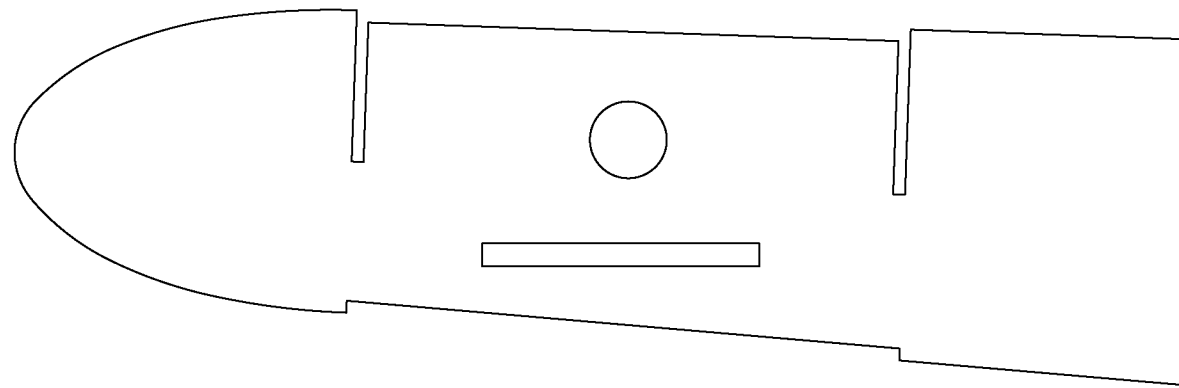
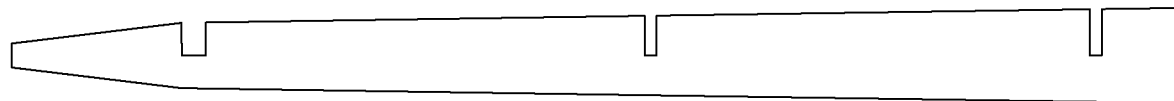
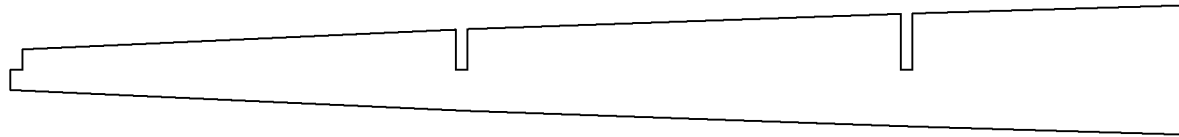
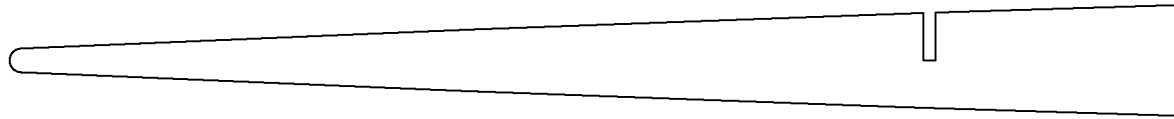
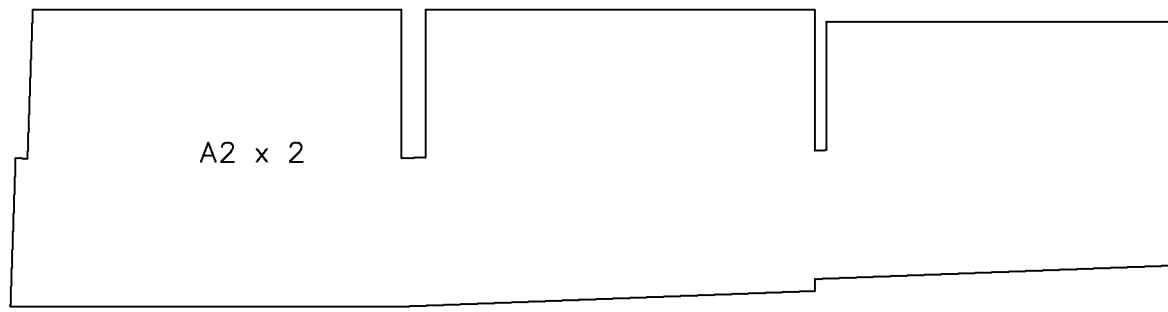

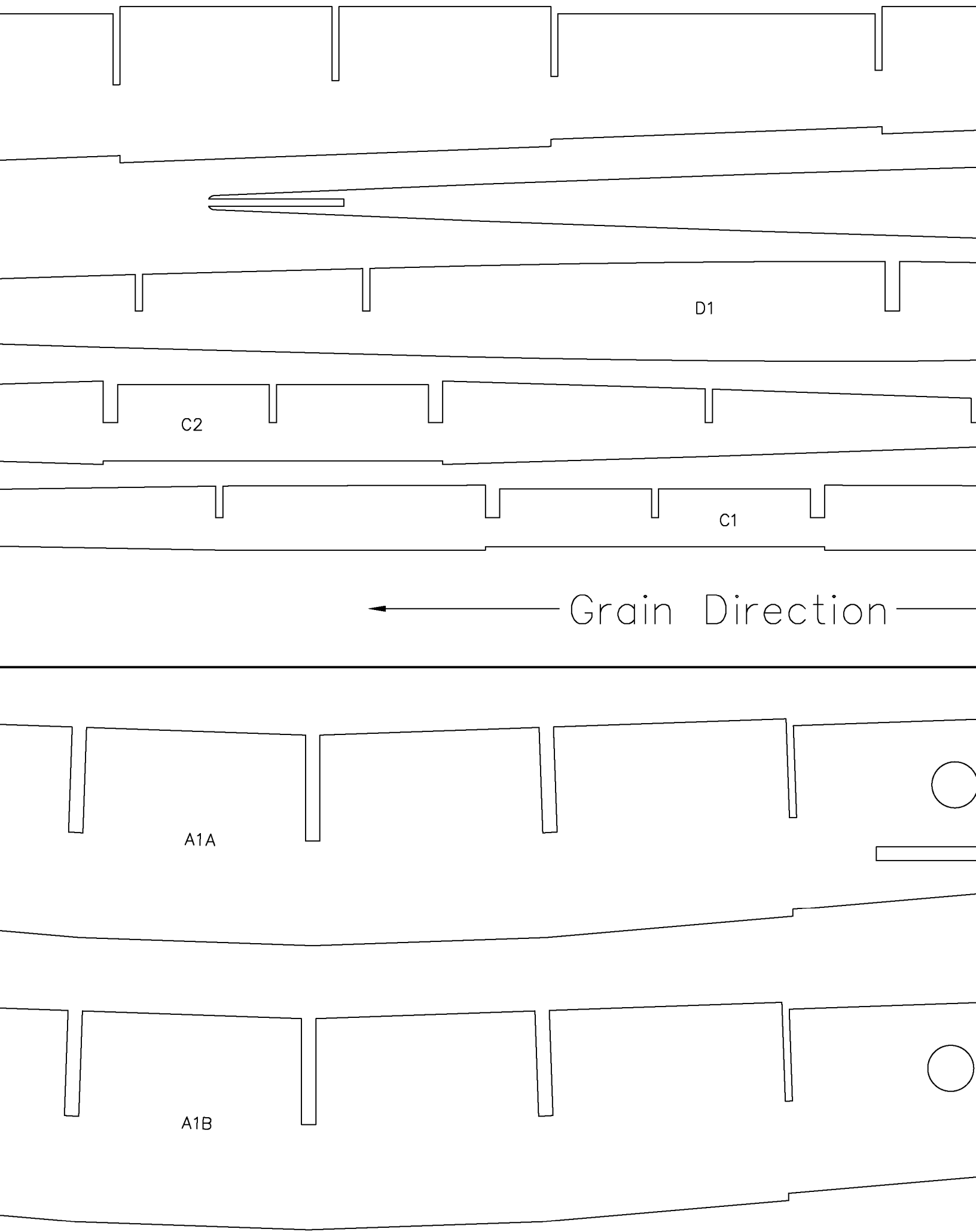

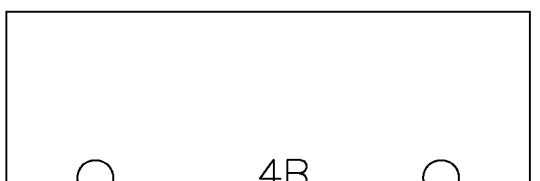
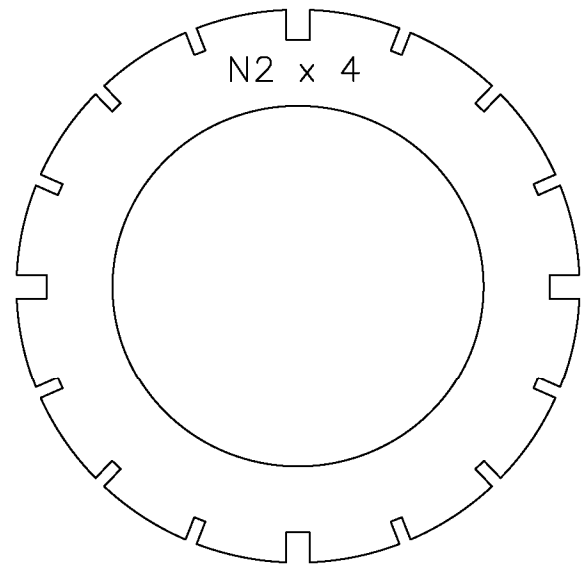
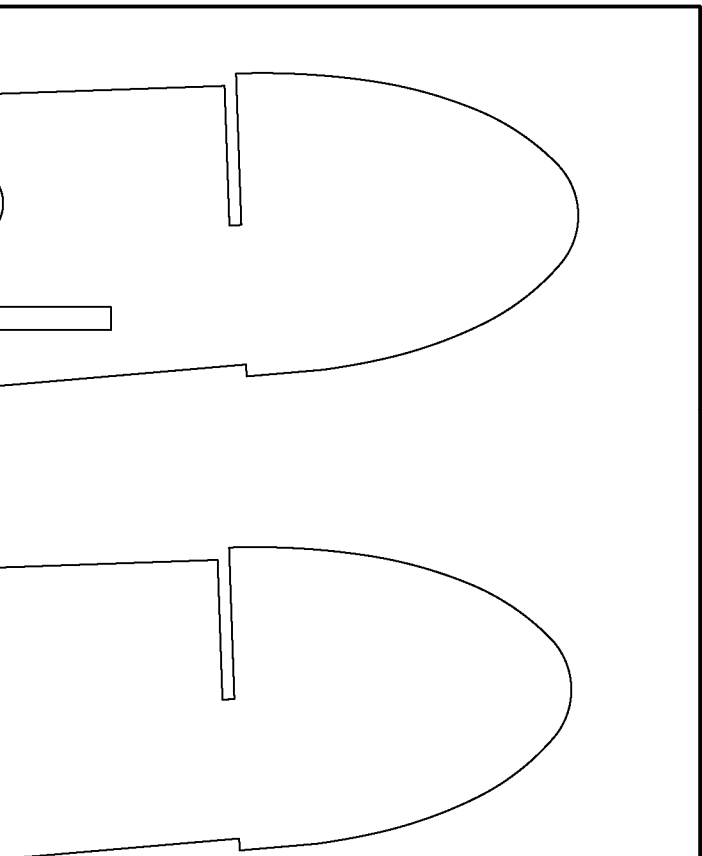
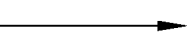
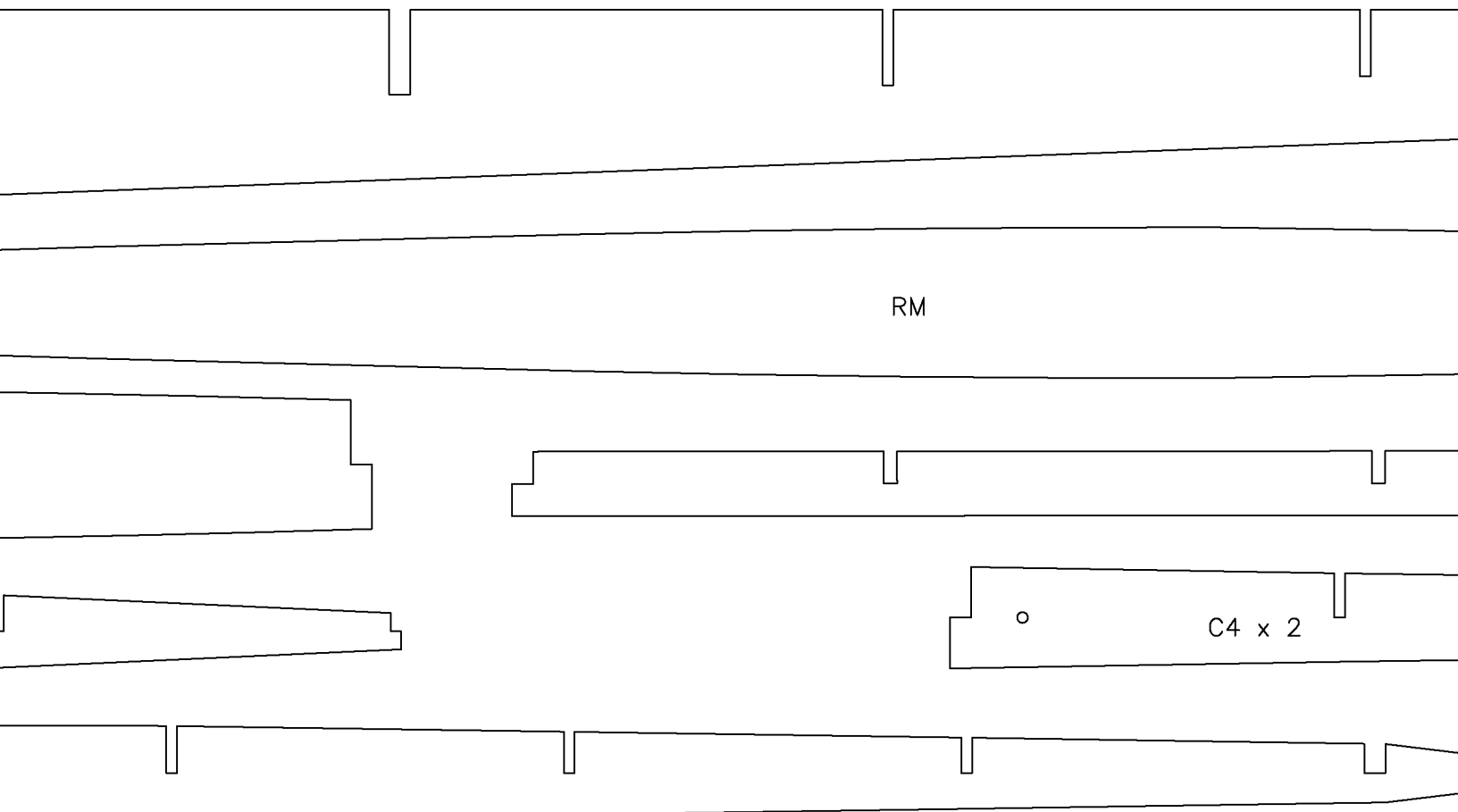

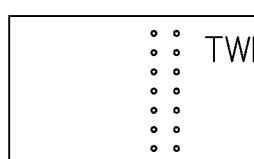
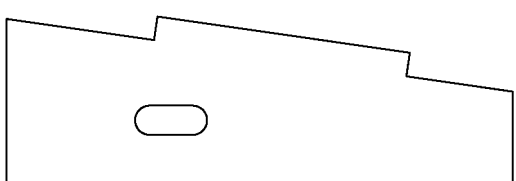
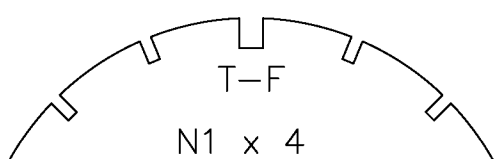
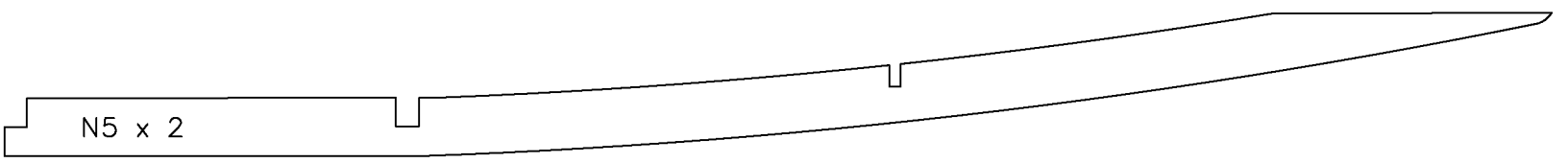
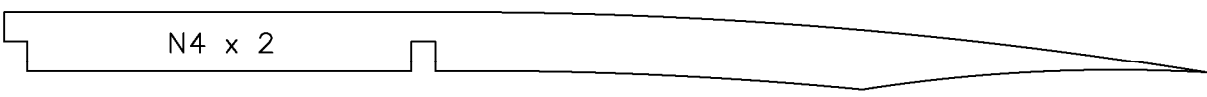
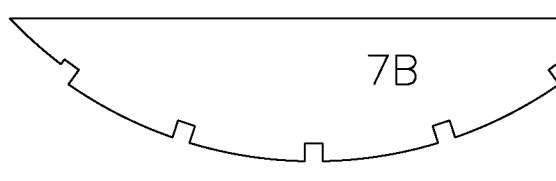
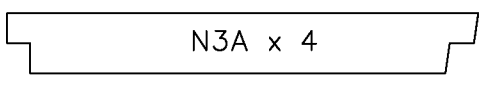
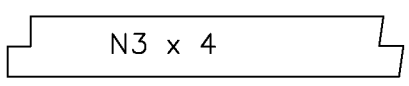
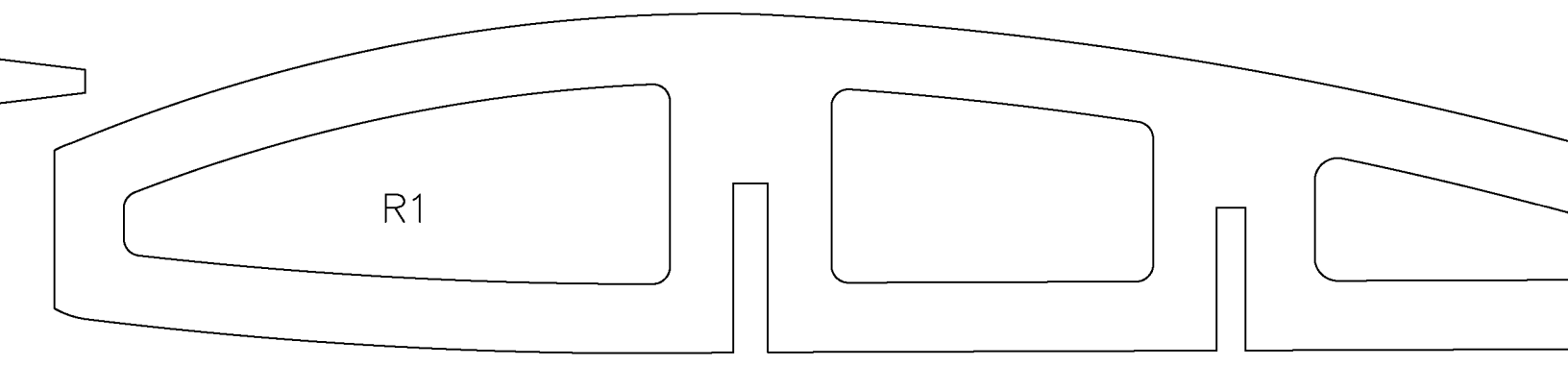
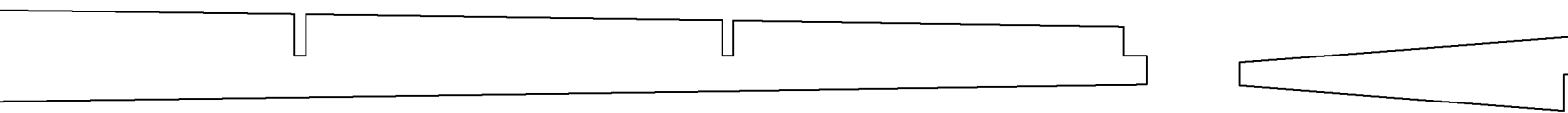
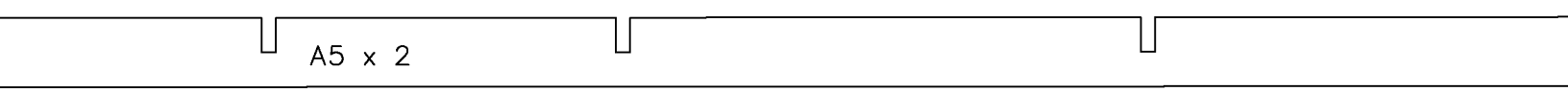
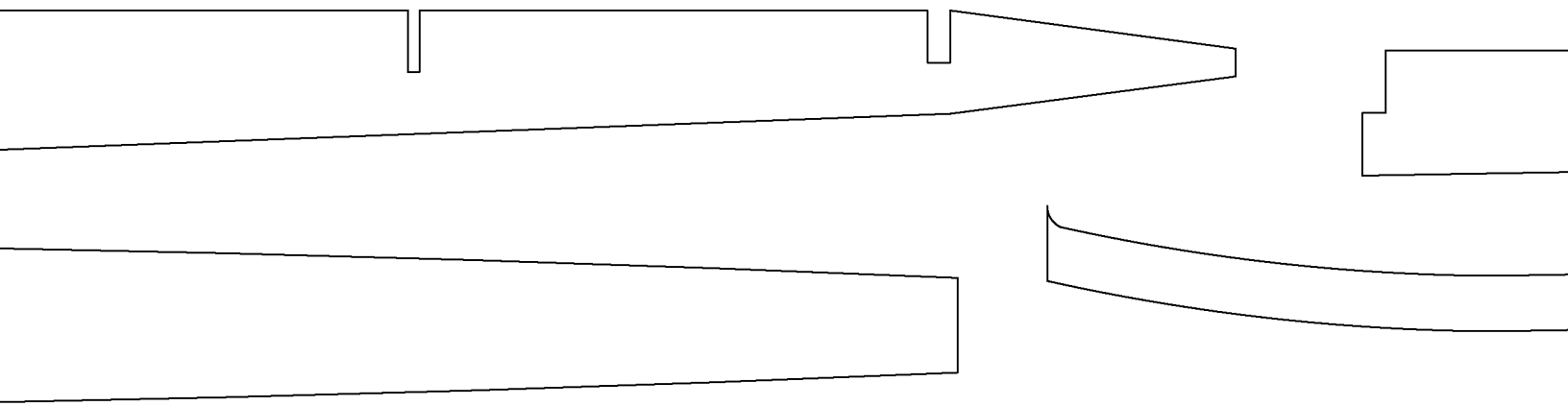



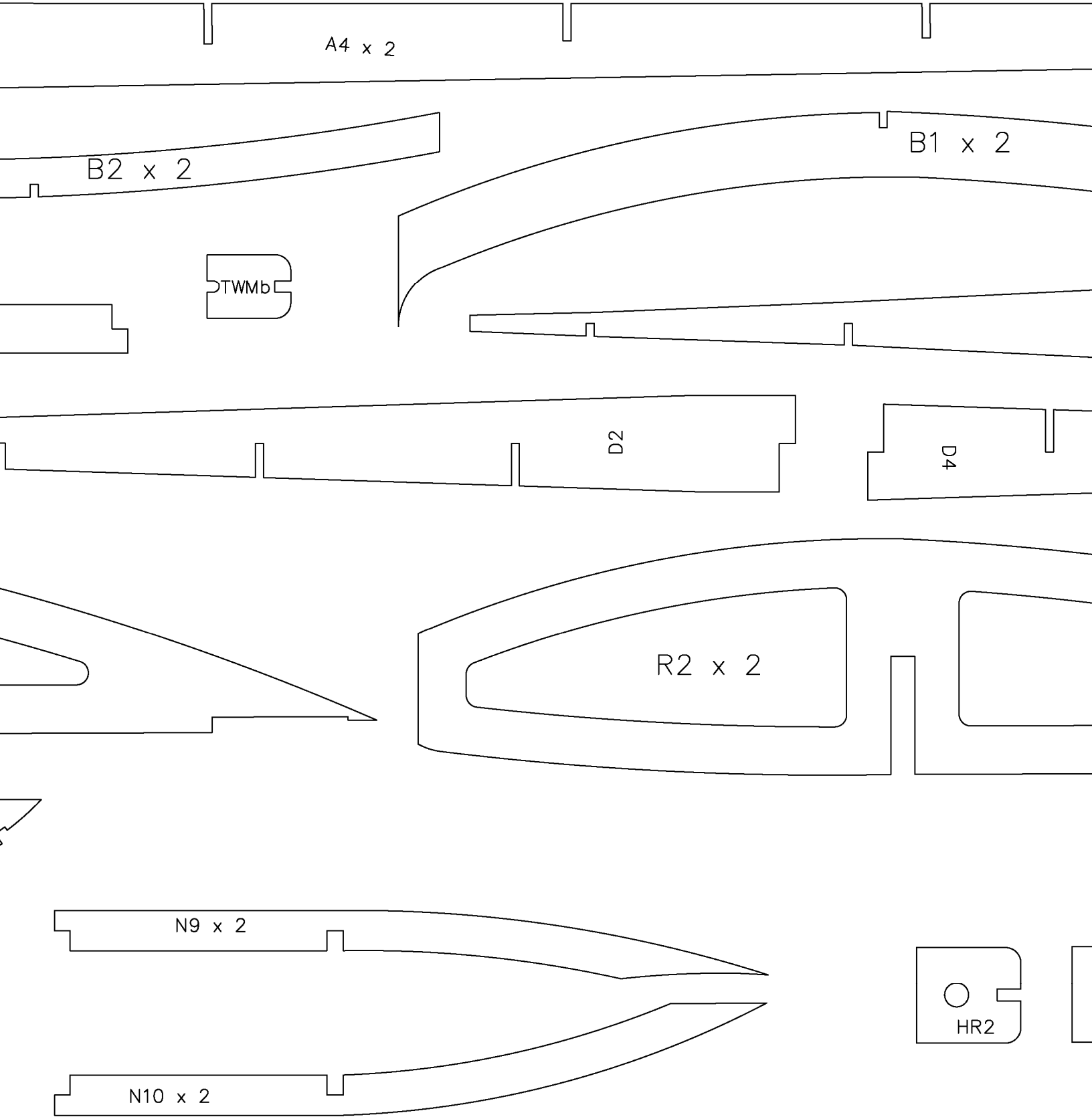

Ma	TWM	•••••
----	-----	-------

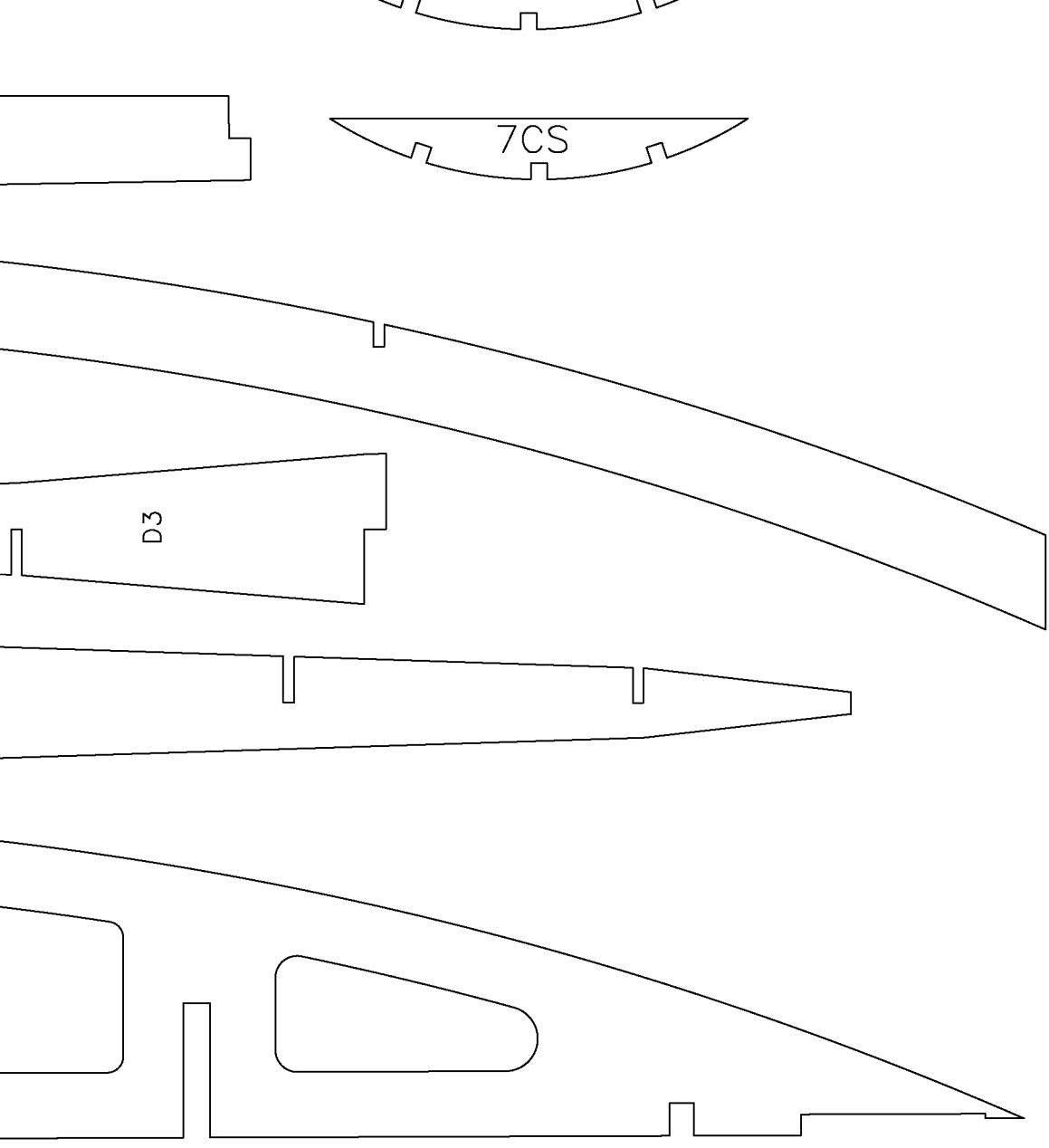

○  
HR1

○ PRS0 x 6

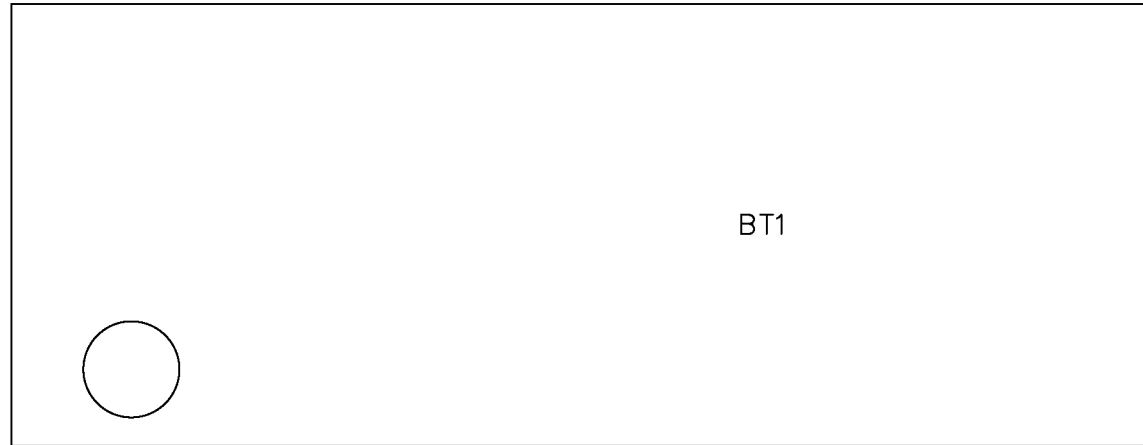
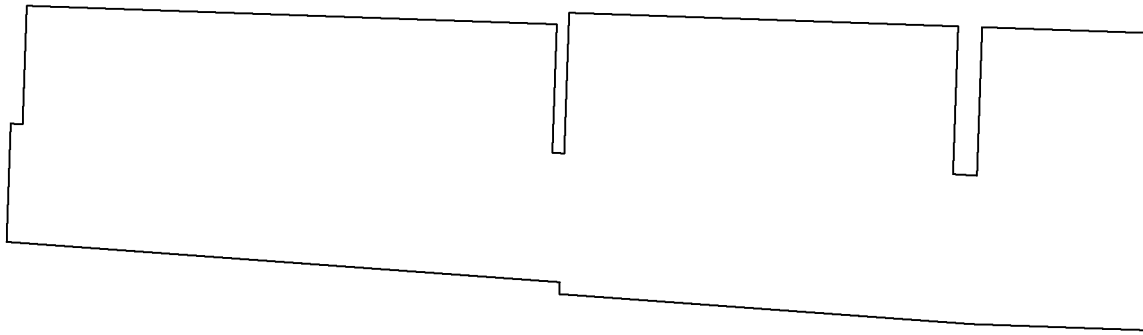

A2A

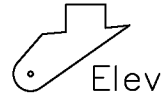
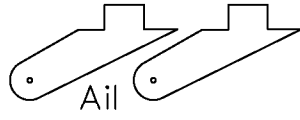
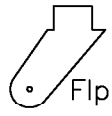

1/32 Ply

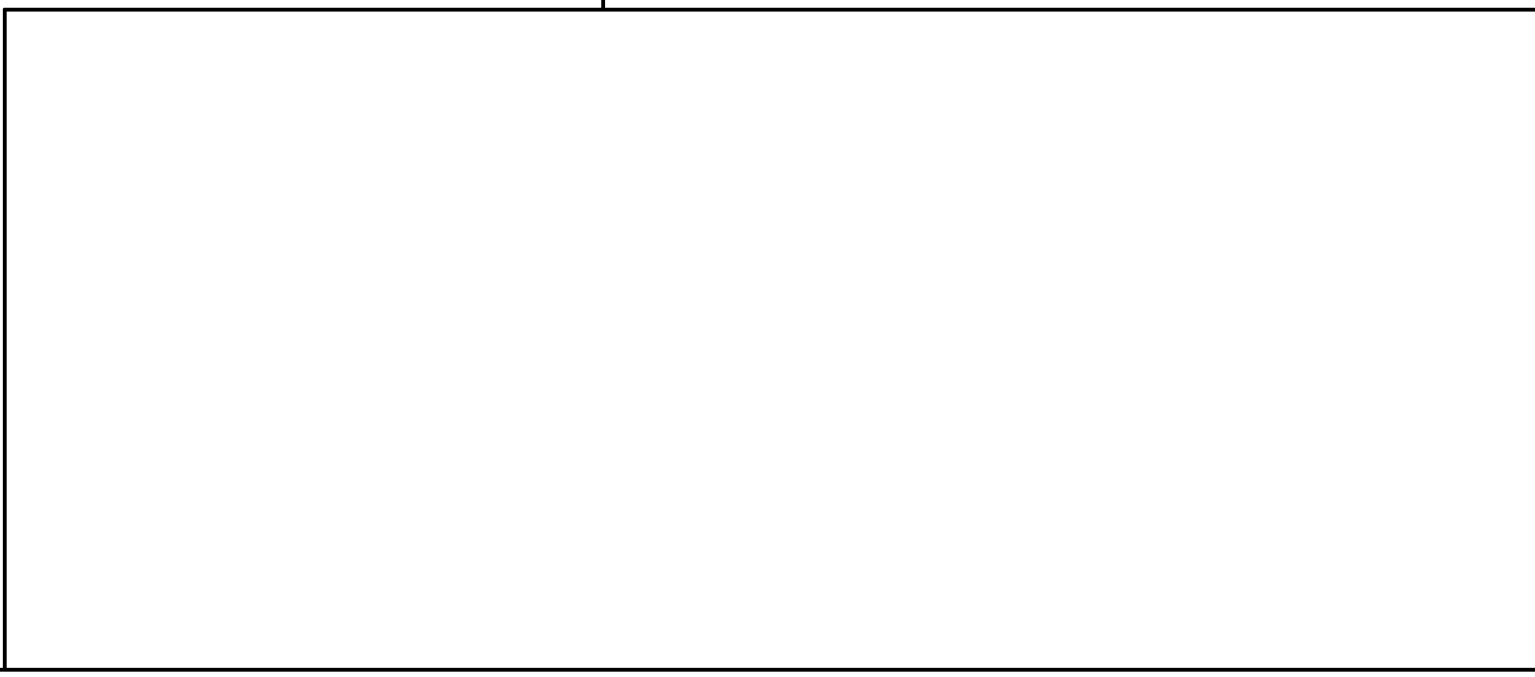
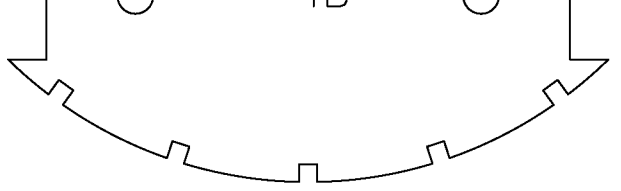

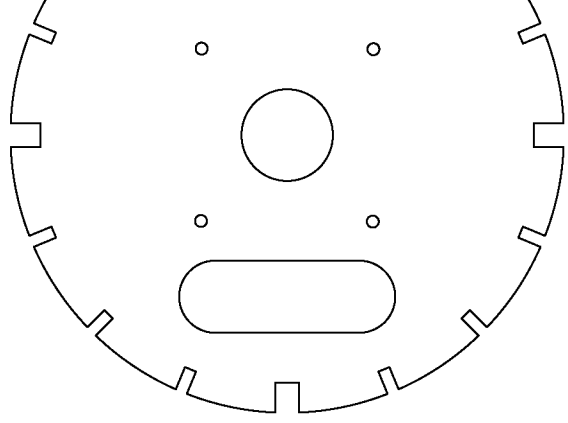

1/8 Lite Ply

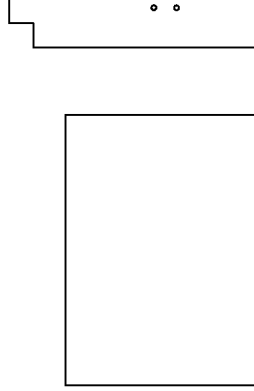
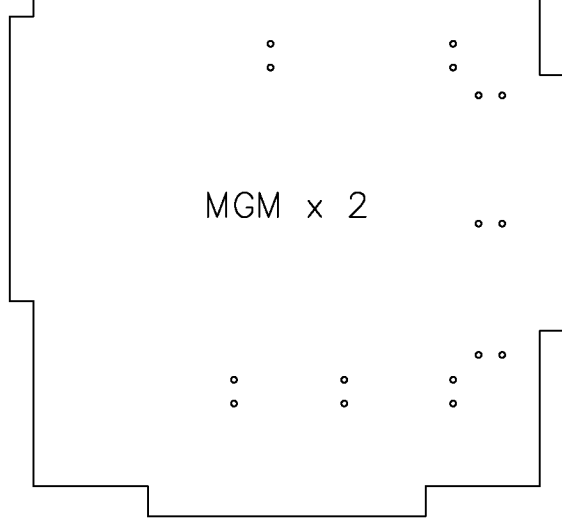

1 inch reference square



• •

WHD



Copyright 2024



and **ModelAviation**

Copying for resale of this drawing without  
the written approval or consent of AMA  
is expressly prohibited.

**Plan No. 1141**

B-17F "Memphis Belle"

Span: 60" | Length: 44 5/8"

Wing Area: 475 Sq. In.

Flying Weight: 42.8 Oz.

Designed. By: Pat Tritle for  
Model Aviation Magazine

Sheet 4 of 4 © 9-25-2023