

TBX-1

Wing

7.2.2016

Sar

End rip #15

10mm

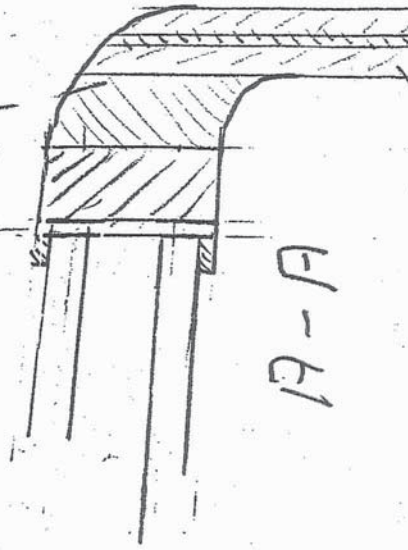

19-A

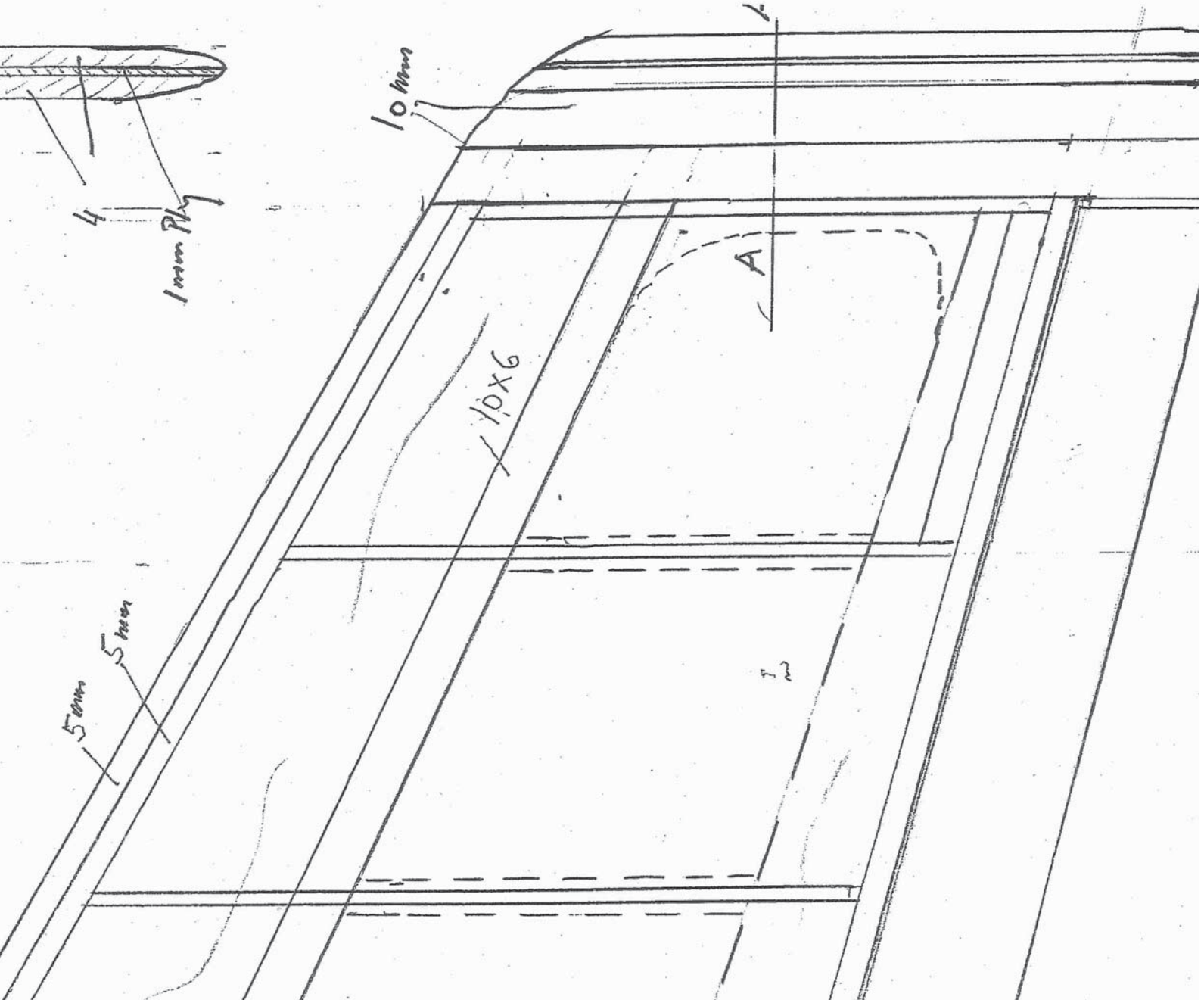

from 5mm (Root)

from 5mm (2mm)
to 2mm (End)

B-B

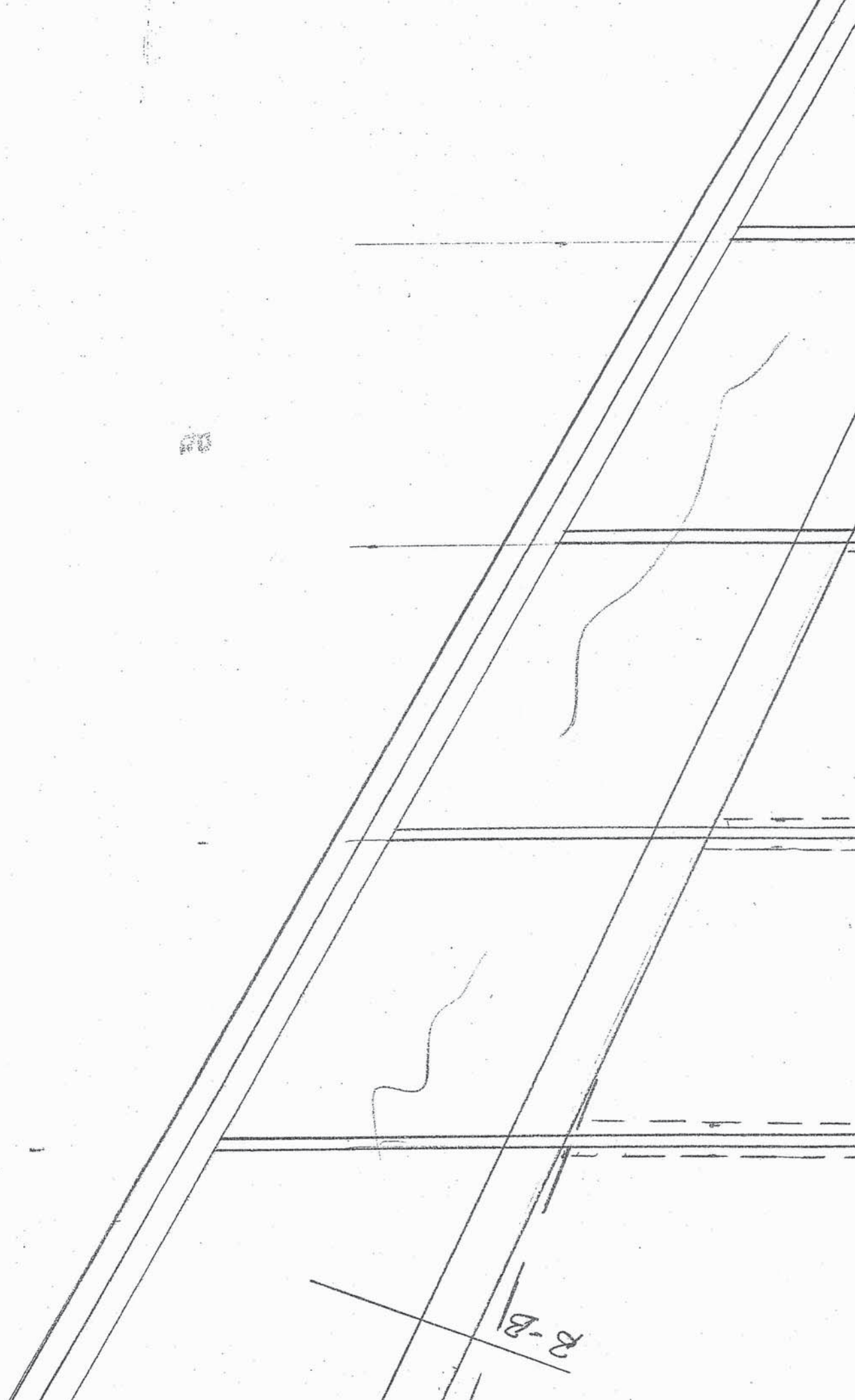
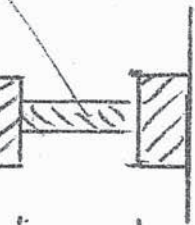

B-B

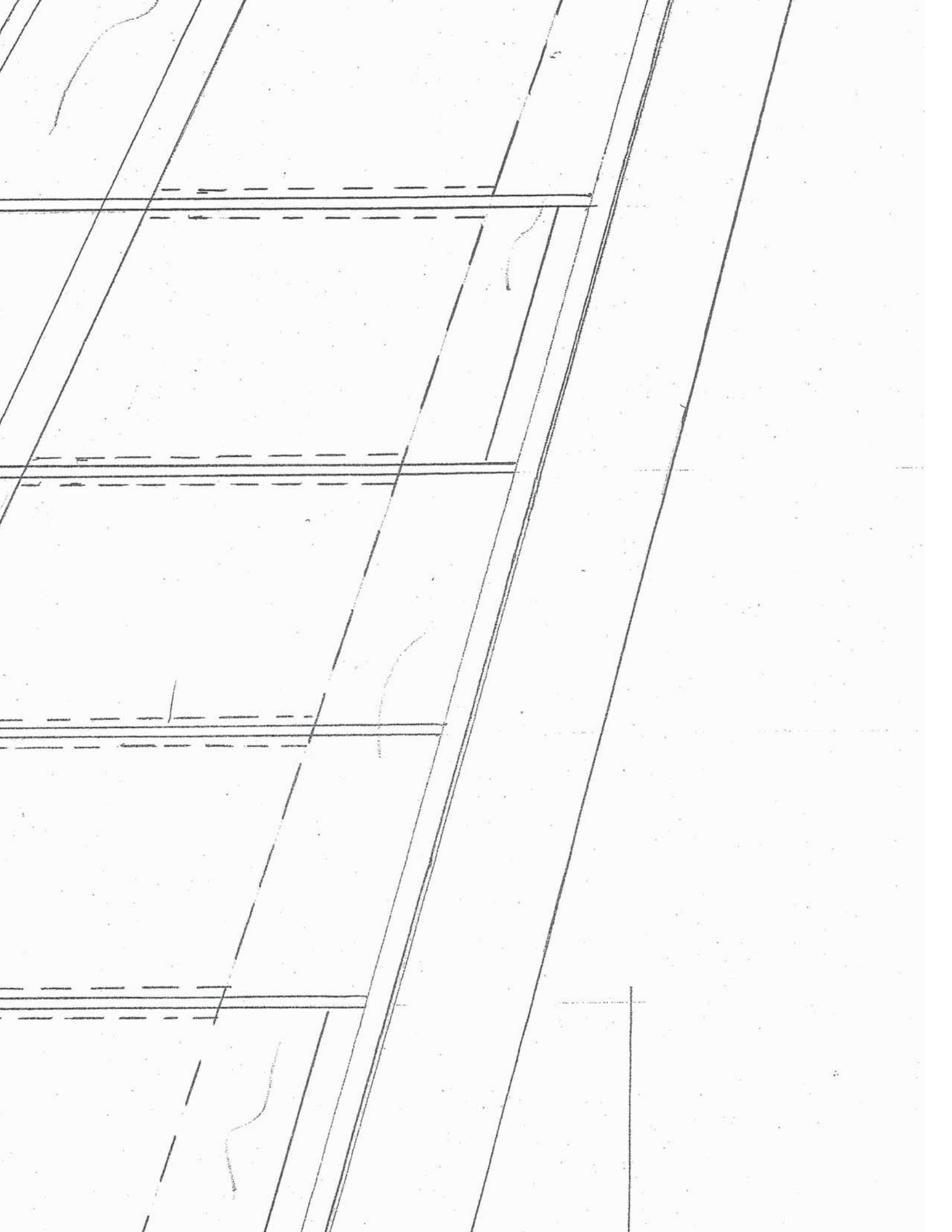

Ply 1 mm
reinforcement

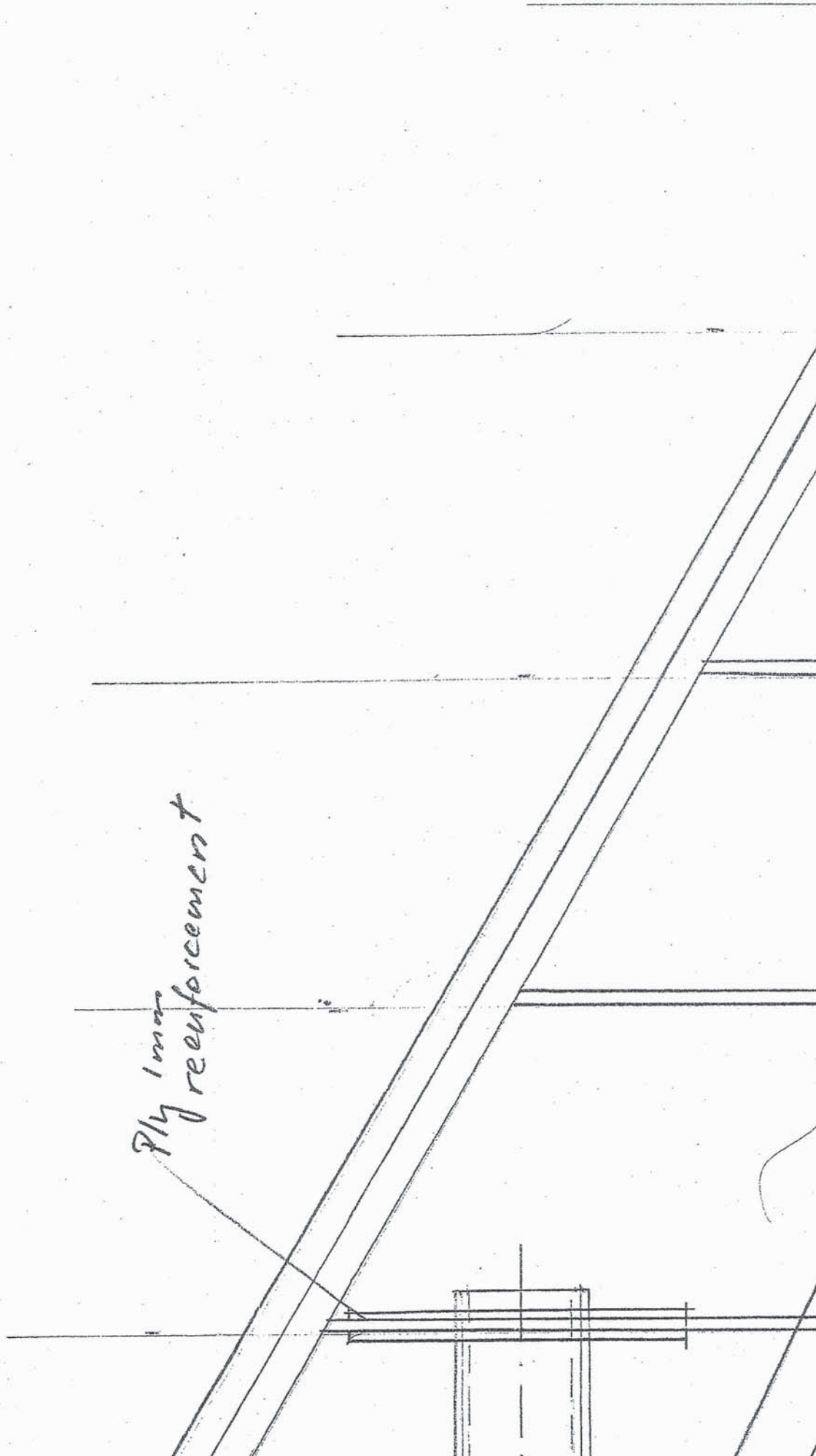

Single spar

End double spar

Double Spar

2.5mm

2.5mm

Carbon

Rec.

Reinforcement for
trusses

2.5mm

A 2415 - NACA 0018

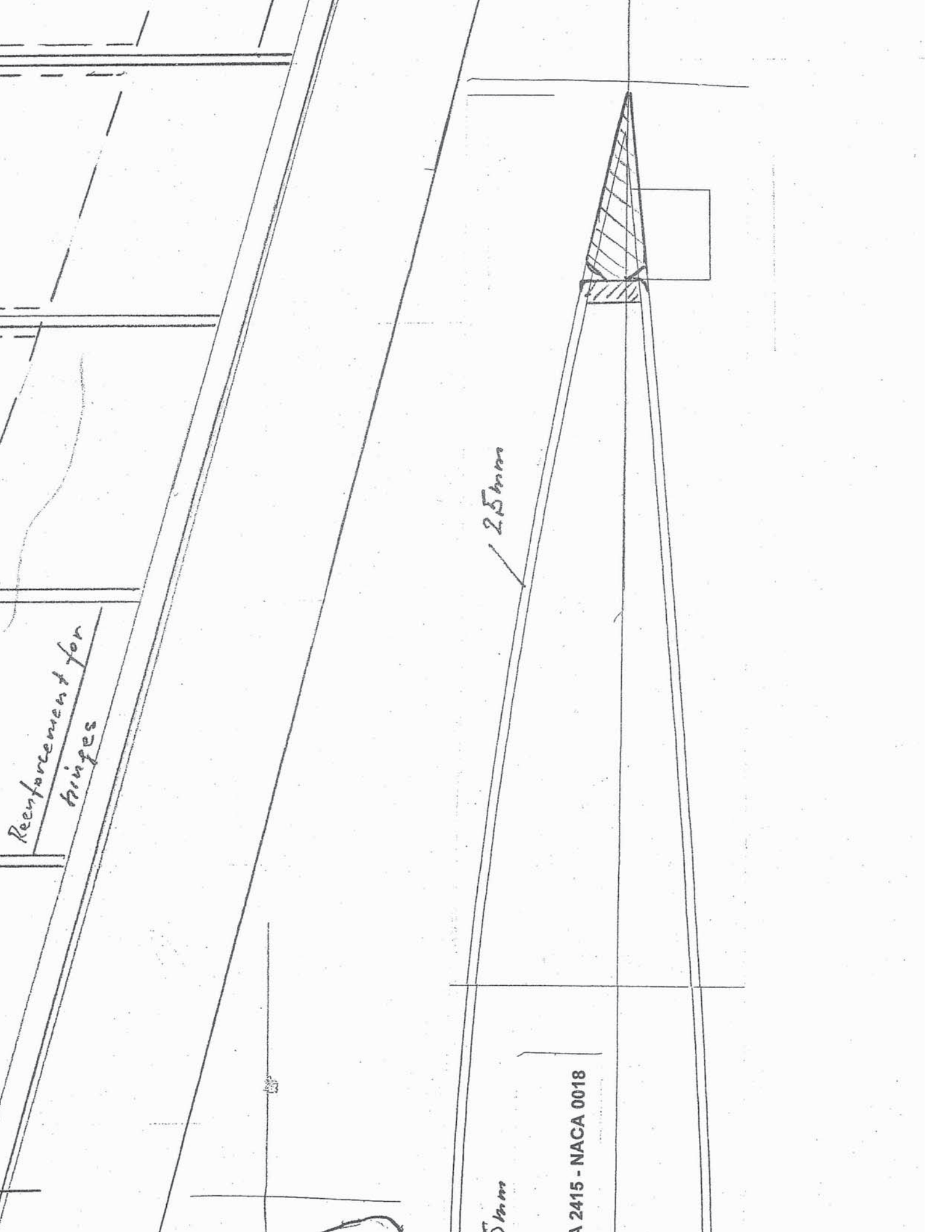

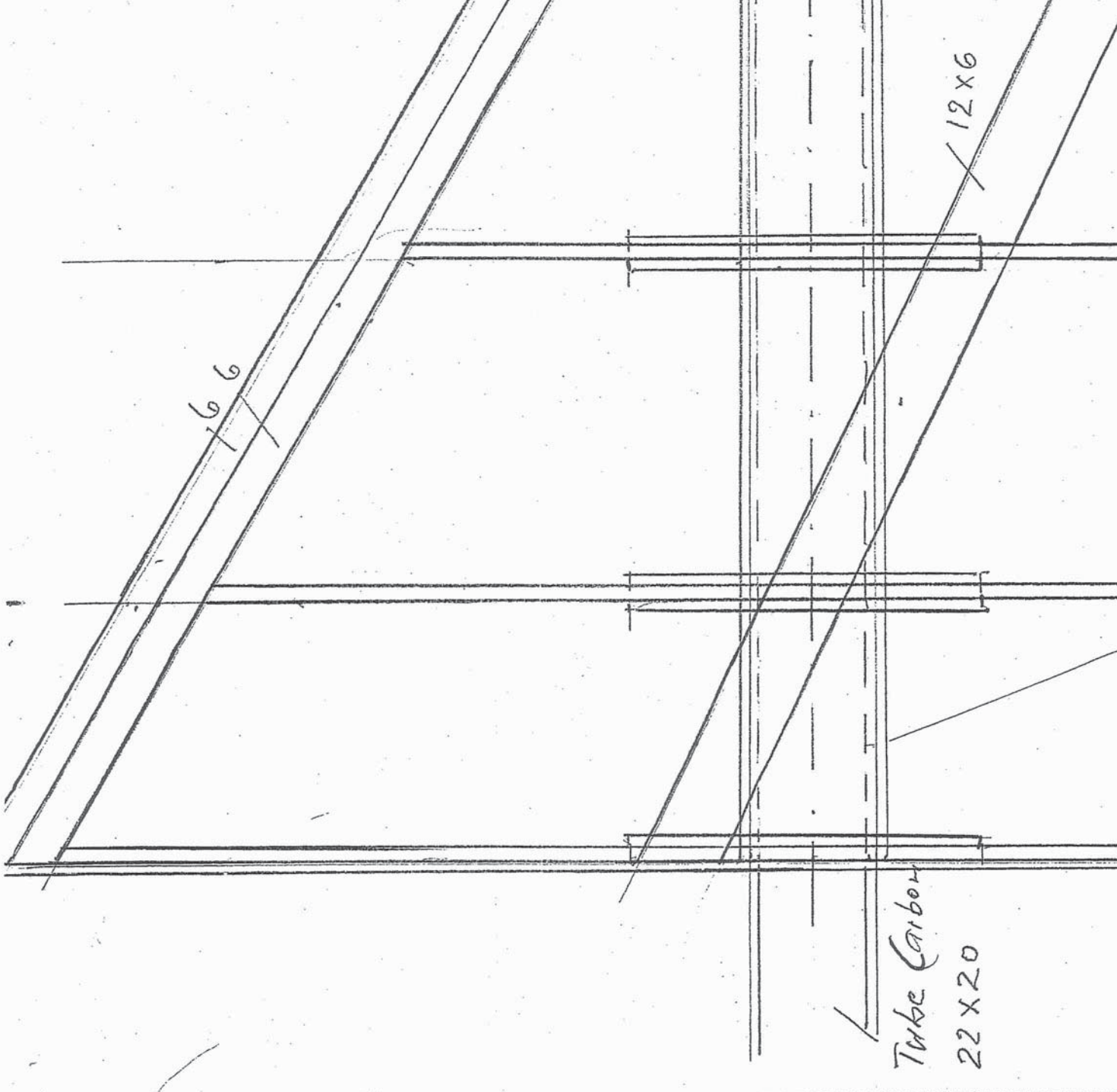

166

12 x 6

Tube Carbon
22 x 20

Centerline
Fuselage

Tube Carbon
10x8

Core from Cardboard Exoxy

Ply 1mm

Ply
1.5mm

Servo

6mm

