

1/16" Balsa - 2 NEE

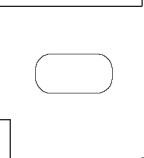

DED

1/8" BALS

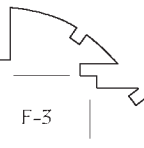
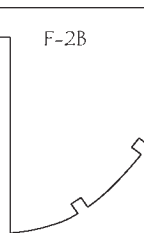
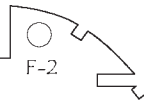
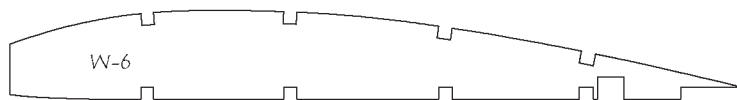
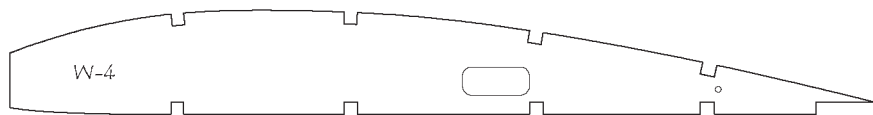
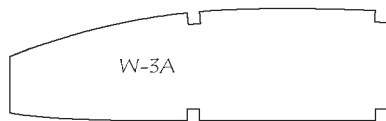
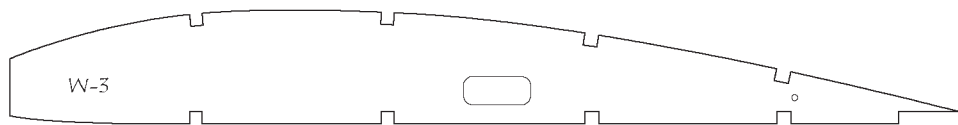
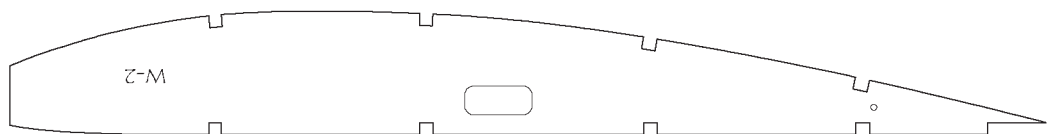
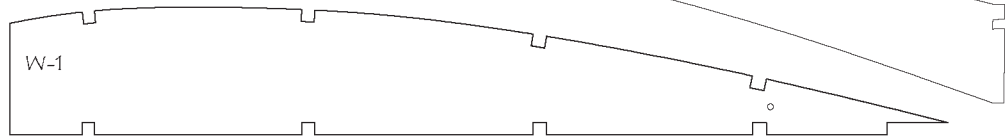
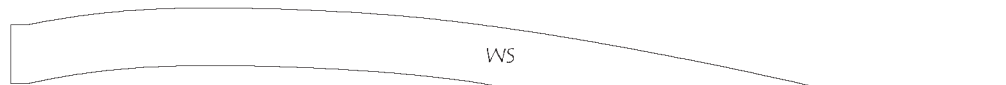
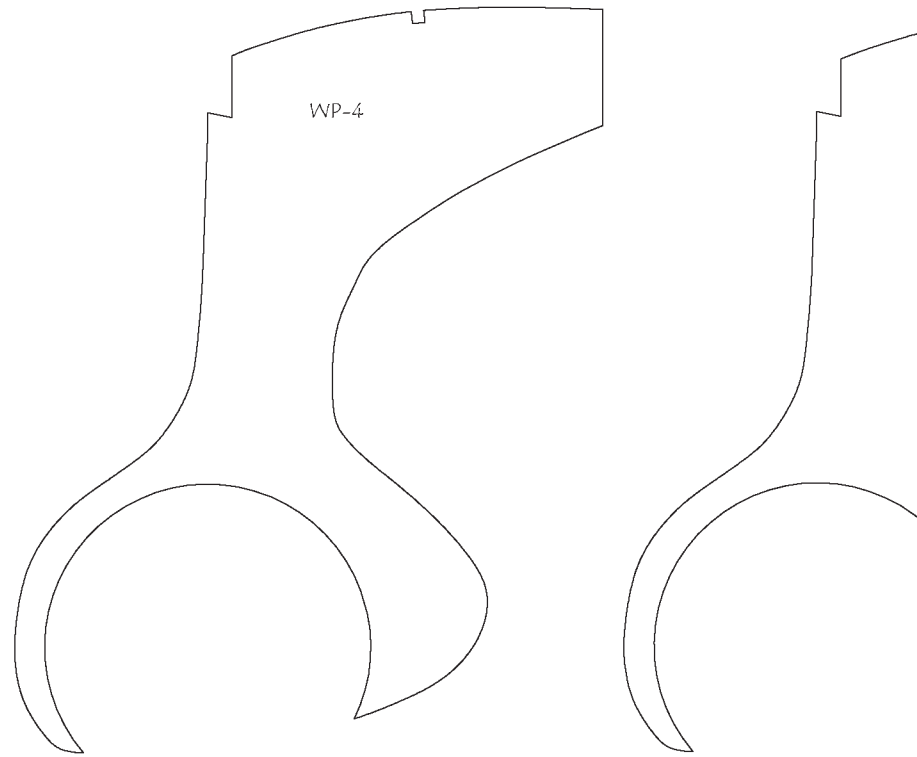
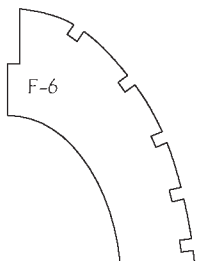
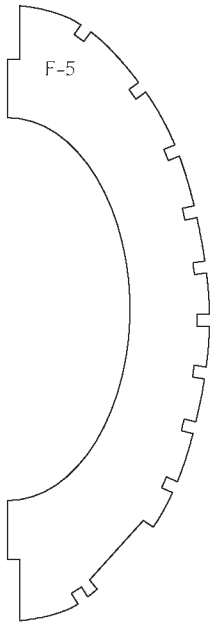
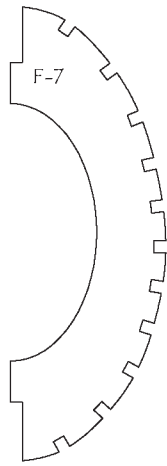
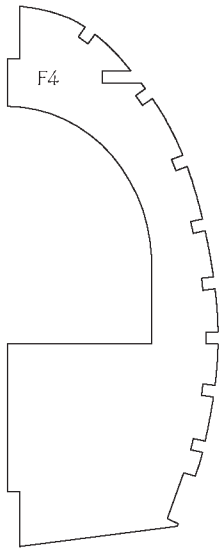

1/8

- 2 NEEDED UNLESS NOTED

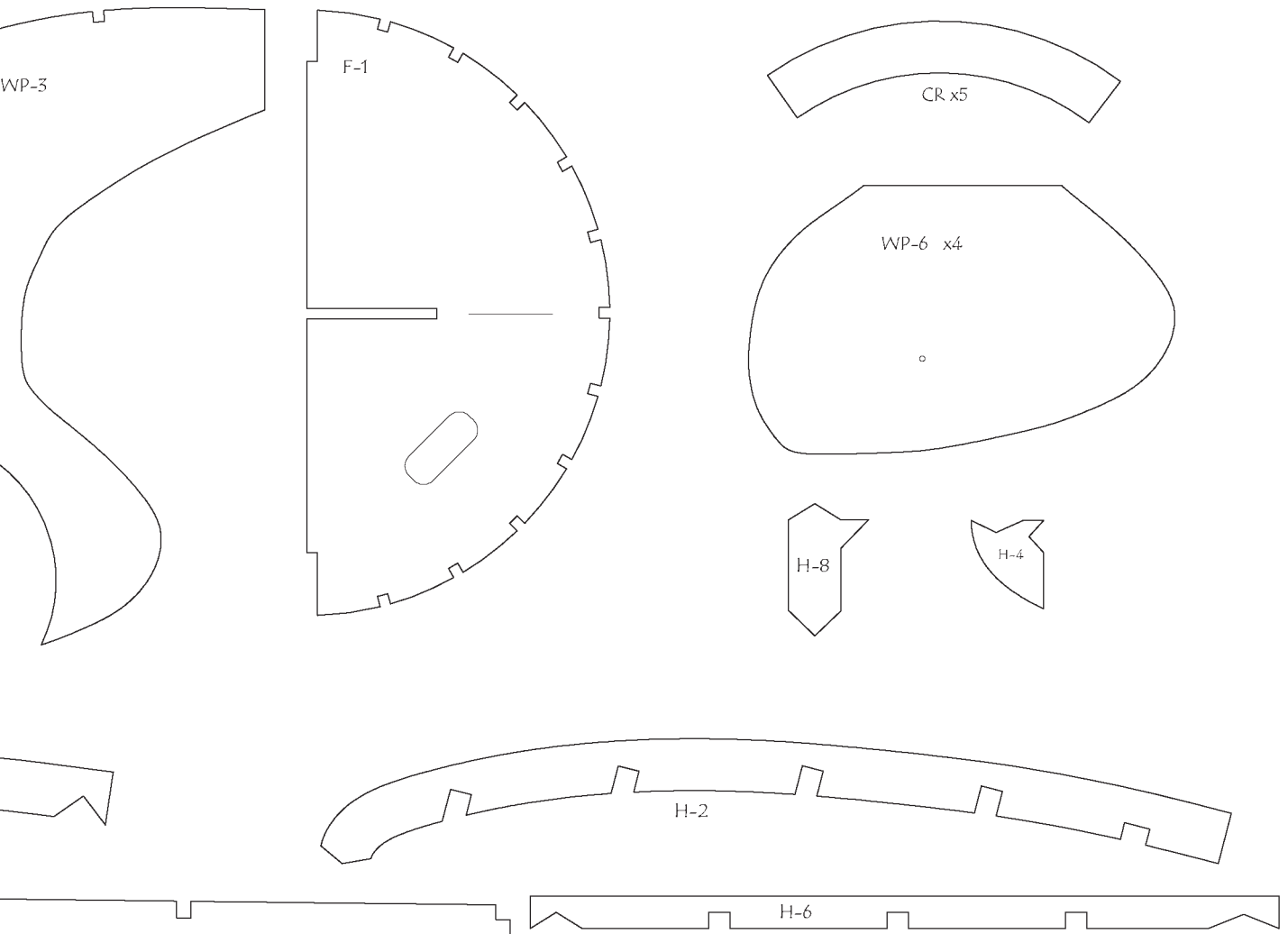

3" BALSA- 1 NEEDED

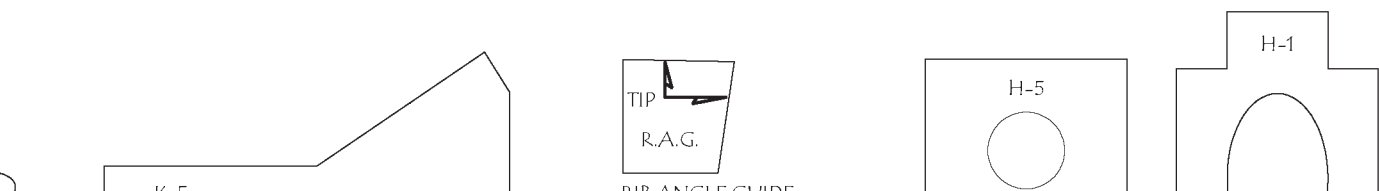

TE-1

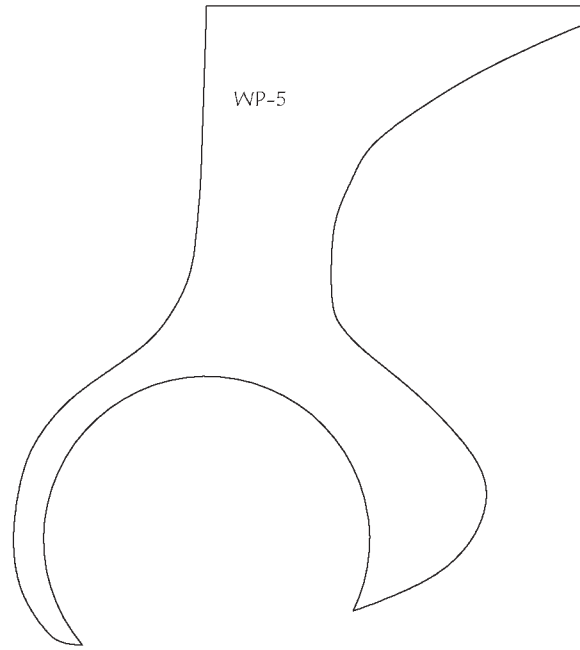
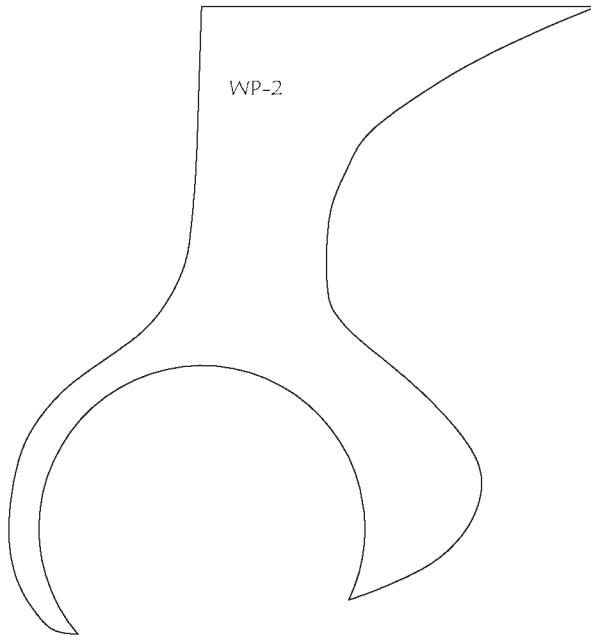

Copyright 2021



and **ModelAviation**

Copying for resale of this drawing without the written approval or consent of AMA is expressly prohibited.

1/16" Balsa - 1 NEB

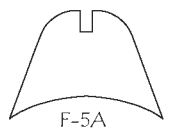
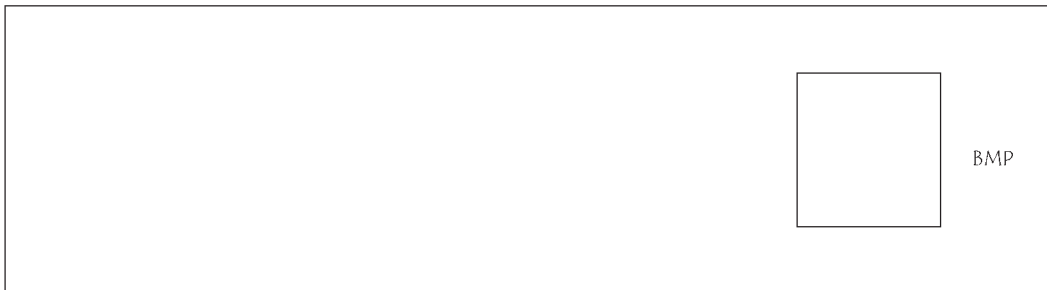

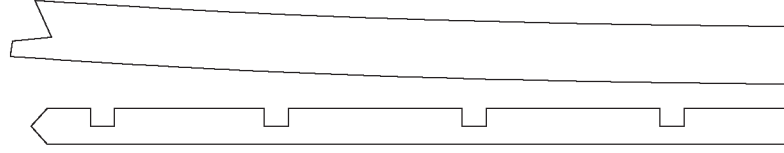
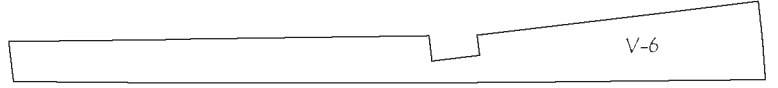
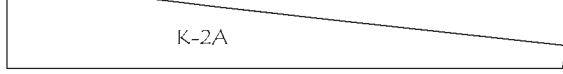
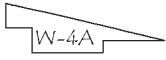
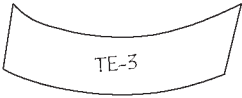
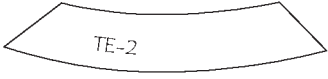
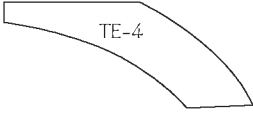
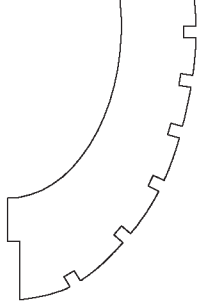

DED

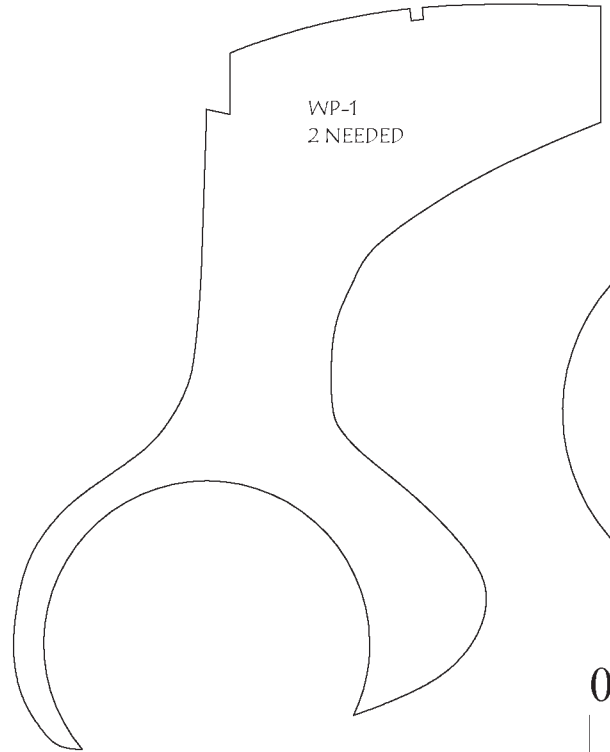
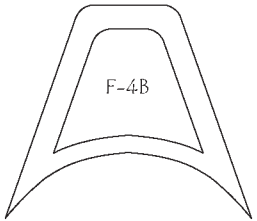

WP-1
2 NEEDED

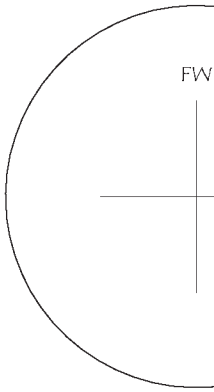

1/

0

RIB ANGLE GUIDE
USE W-1, W-3, W-3A

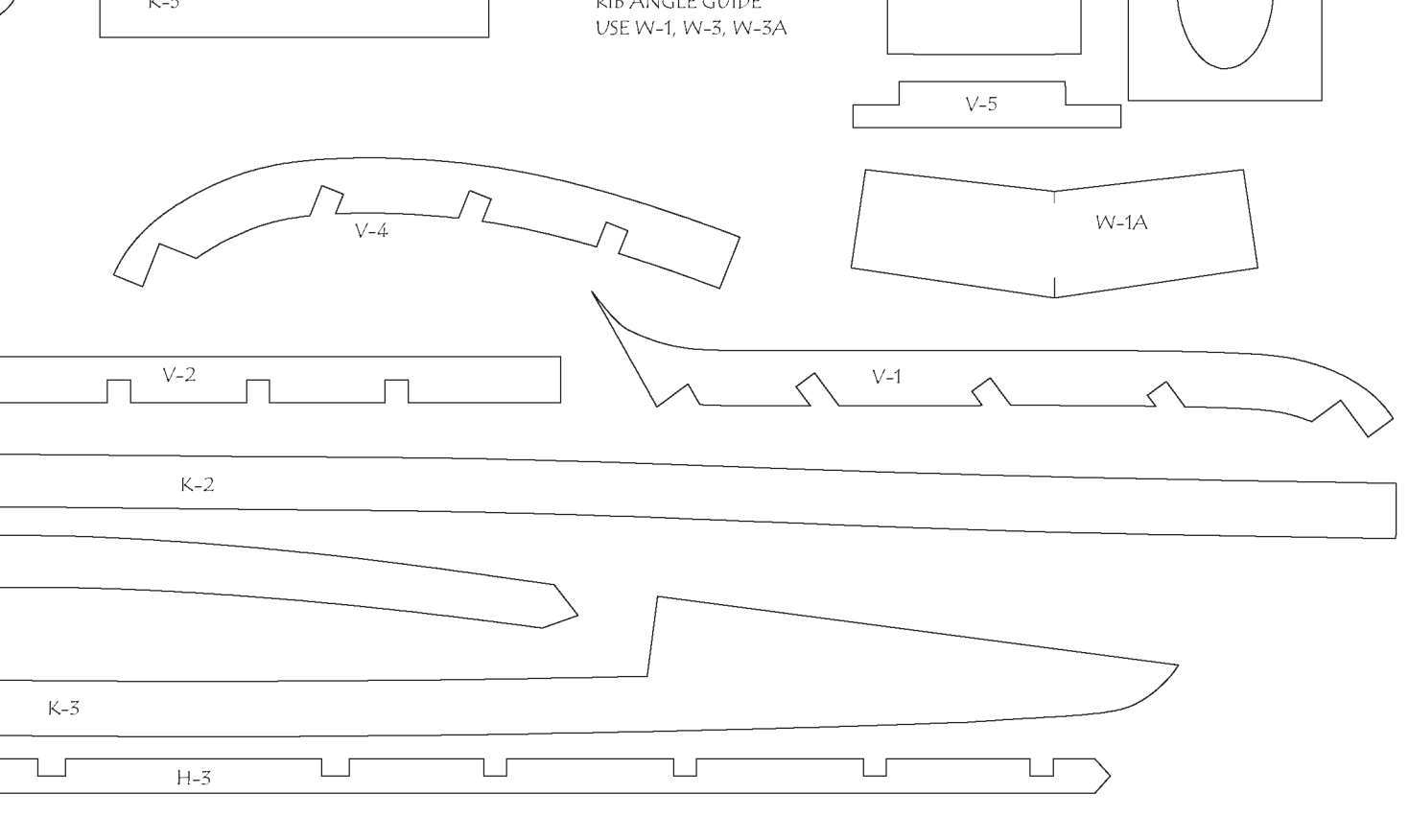

16" PLY

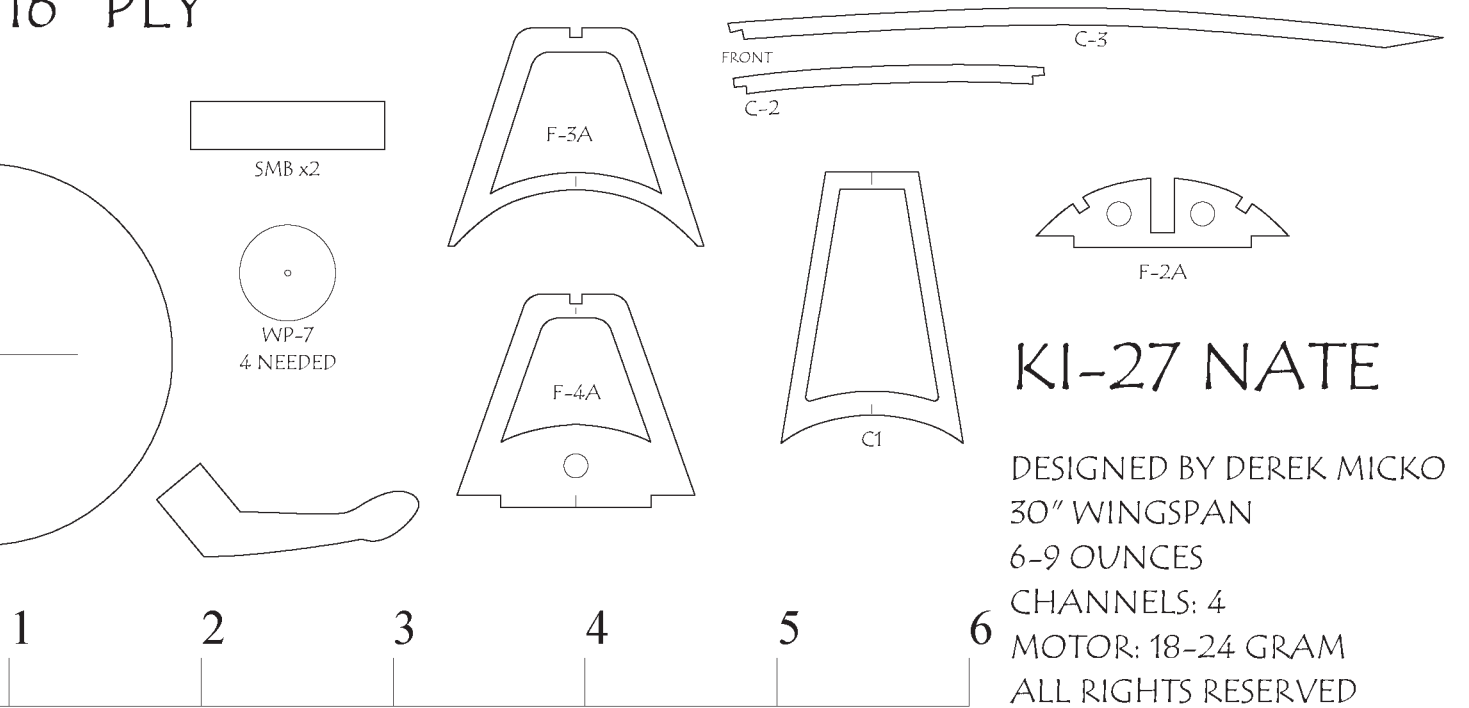

KI-27 NATE

DESIGNED BY DEREK MICKO
 30" WINGSPAN
 6-9 OUNCES
 CHANNELS: 4
 MOTOR: 18-24 GRAM
 ALL RIGHTS RESERVED