

Copyright 2022



and

ModelAviation
Building Models for Everyone

**Copying for resale of this drawing without
the written approval or consent of AMA
is expressly prohibited.**

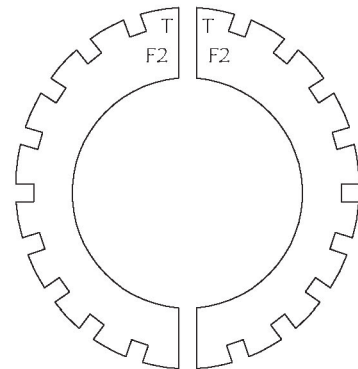
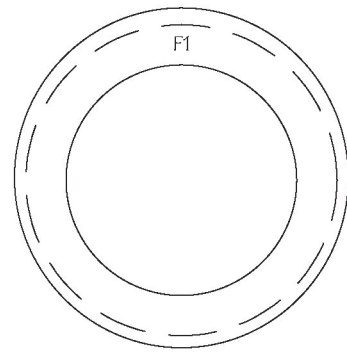

FUSE PARTS

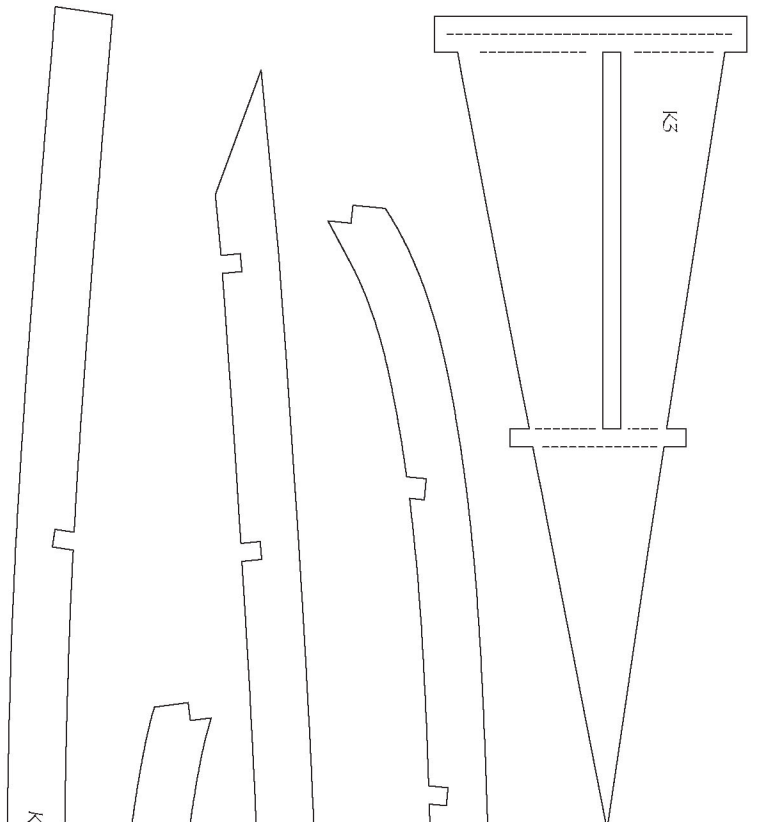
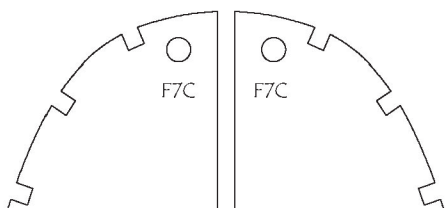
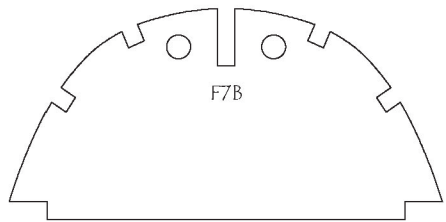
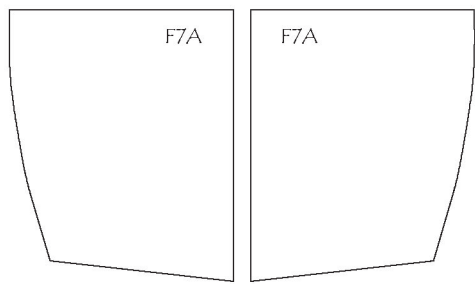

3/32" Balsa

WING PARTS

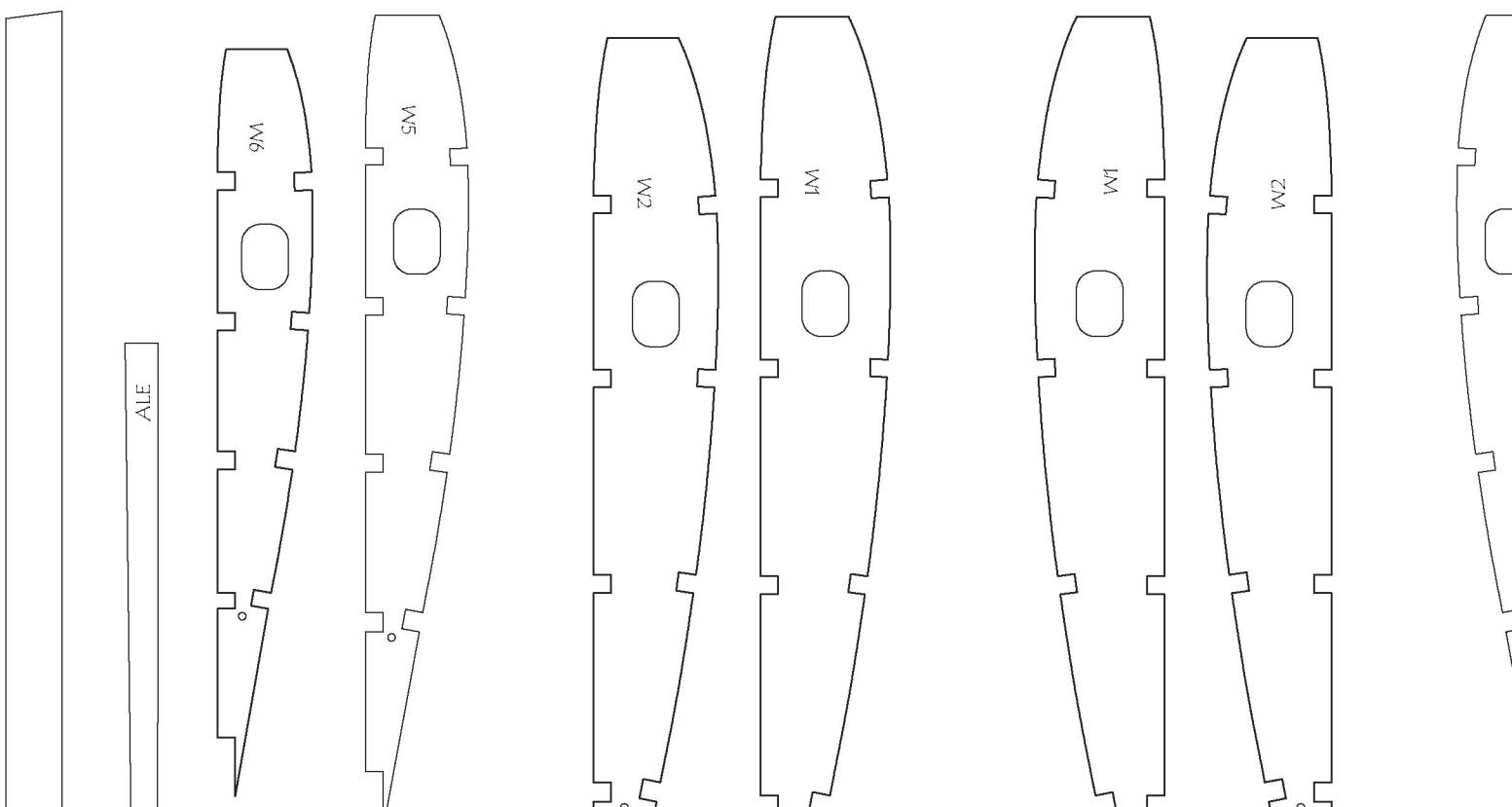

TAIL PARTS

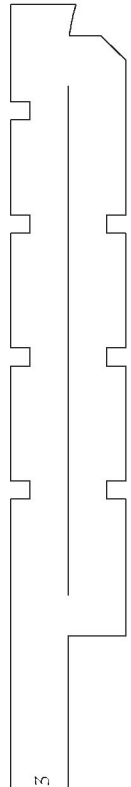
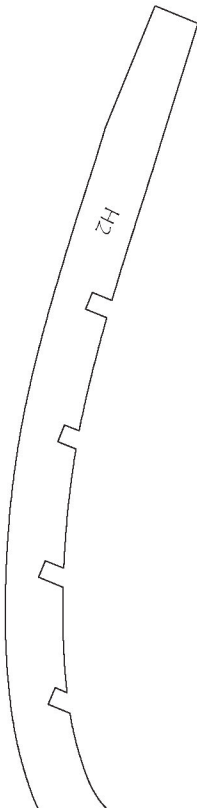
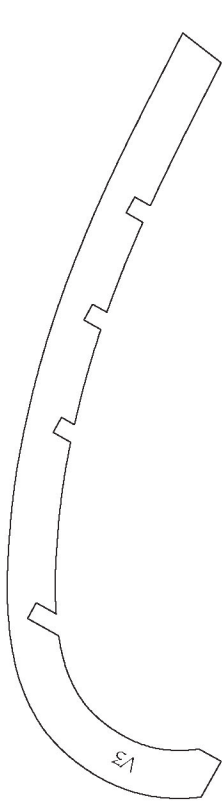
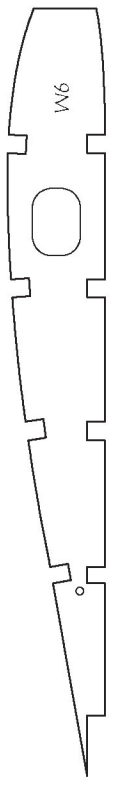
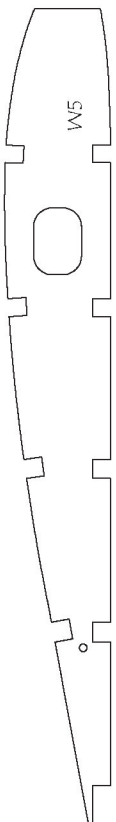

1/8" LITE PLY

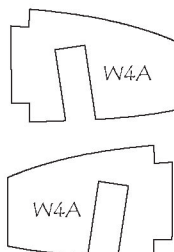
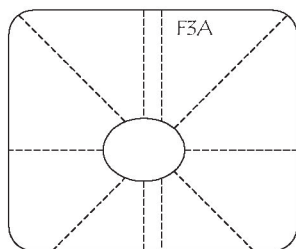
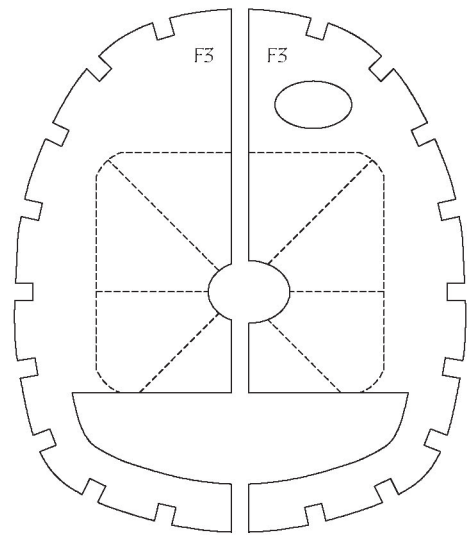

GRAIN DIRECTT



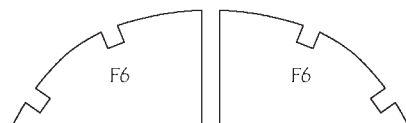
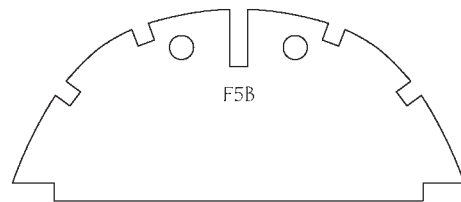
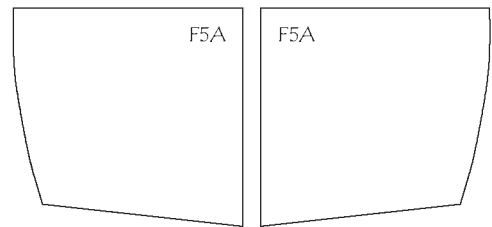
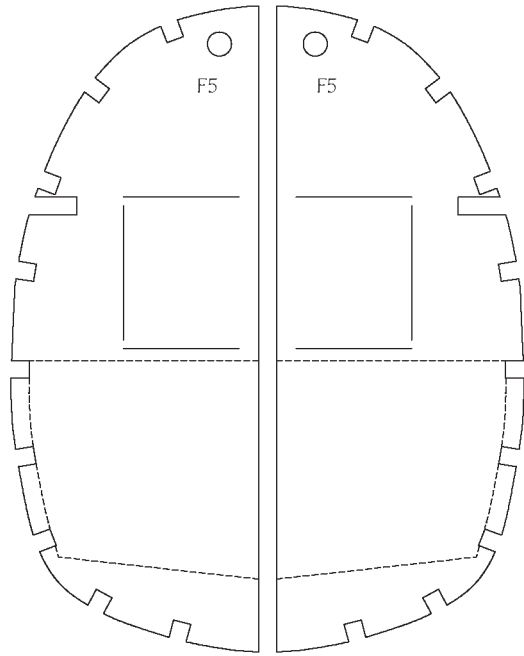
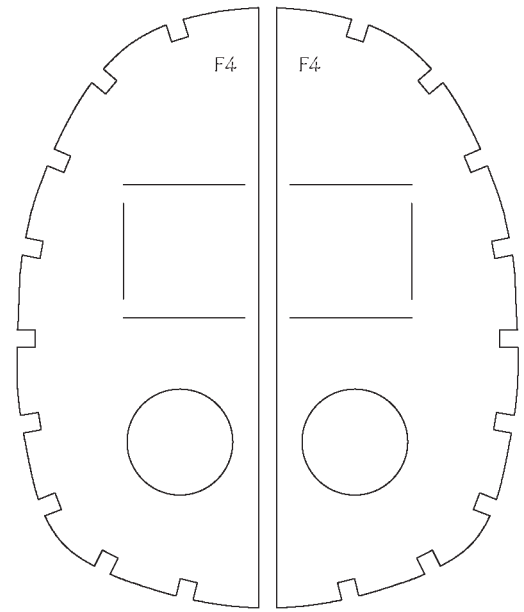

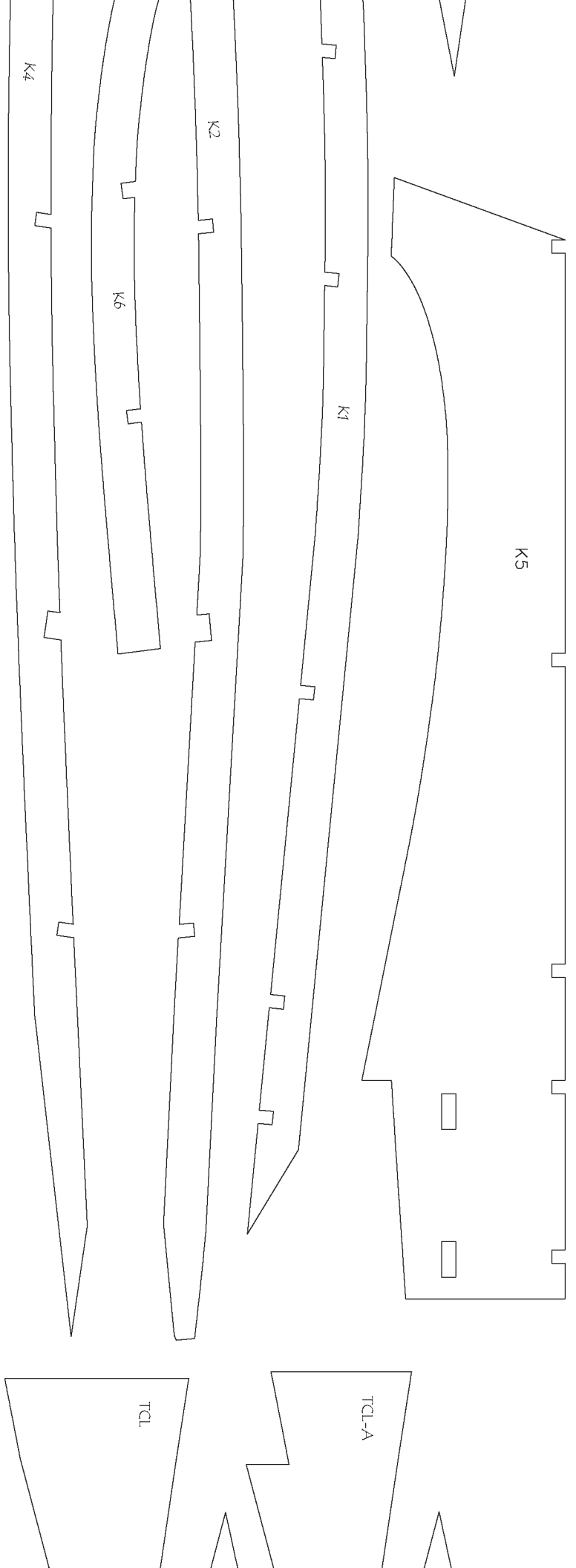
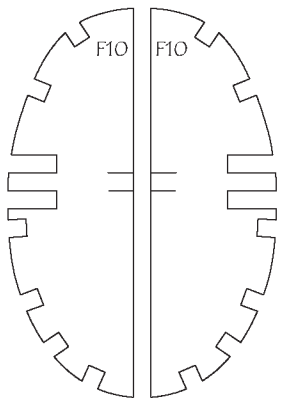
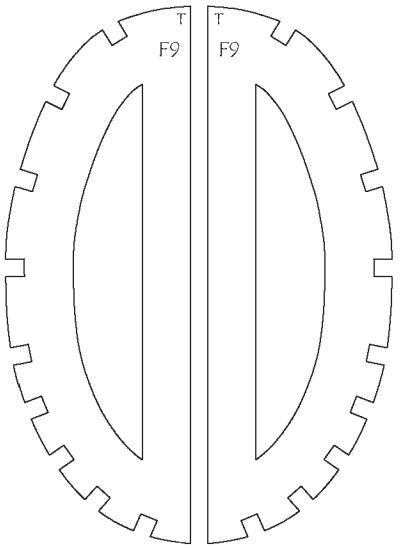
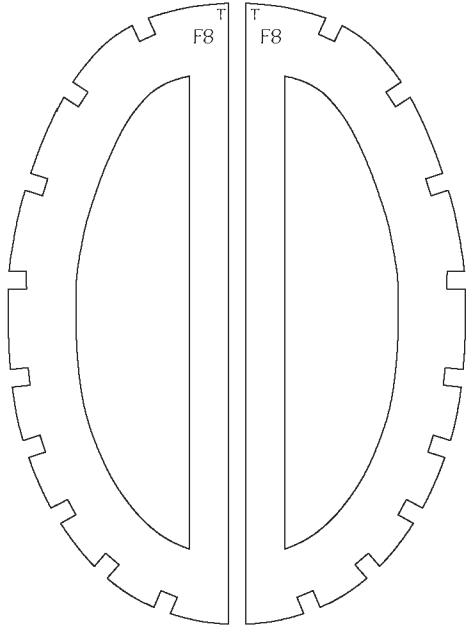
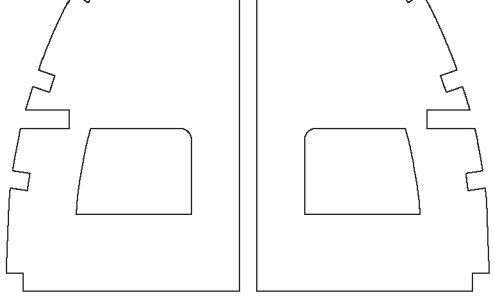

TE1

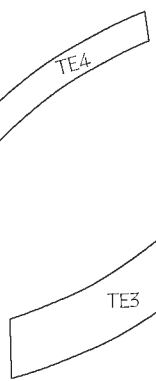
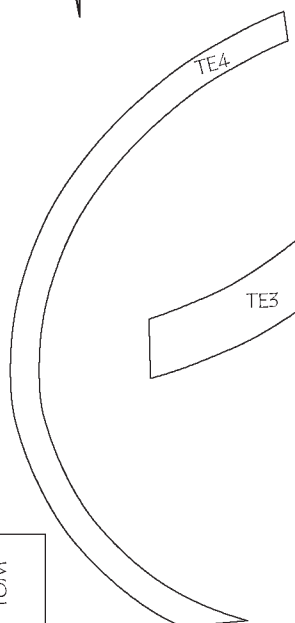
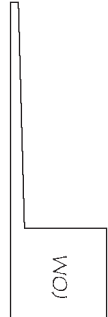
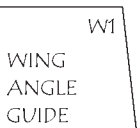
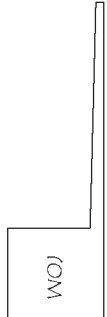
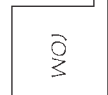
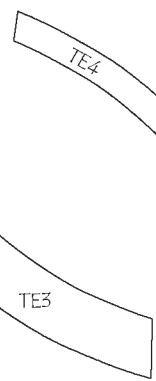
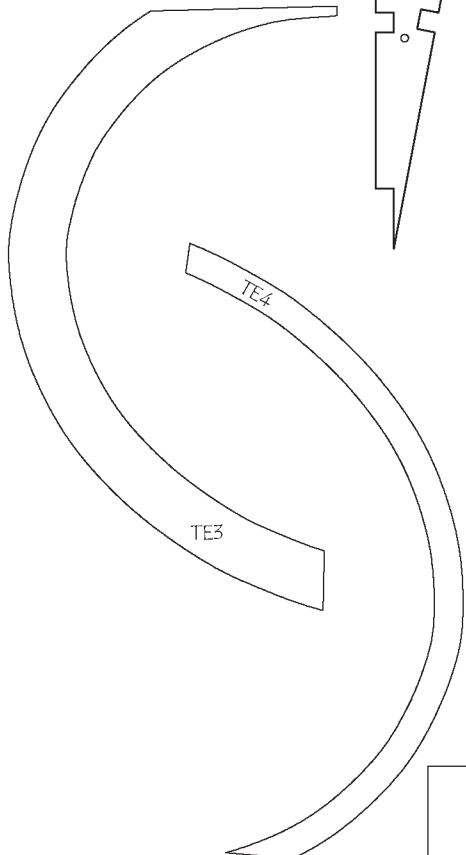
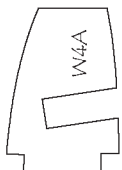
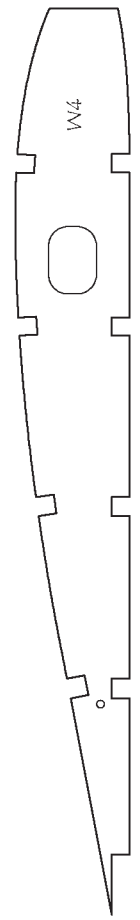
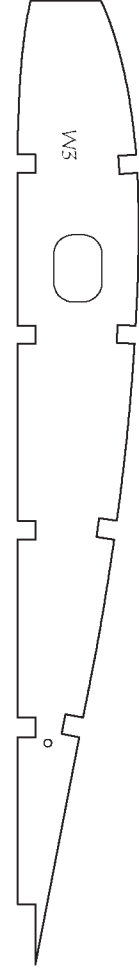
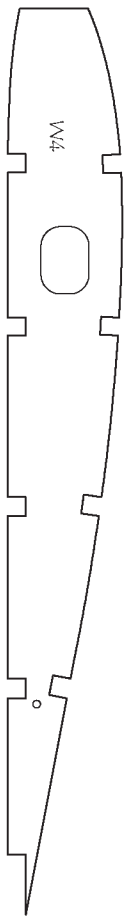
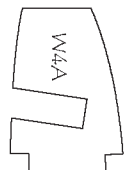
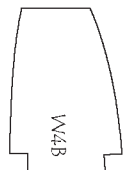
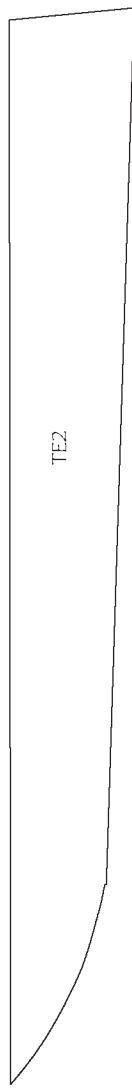
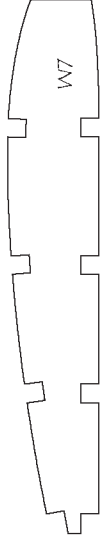
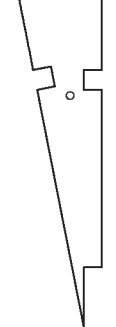
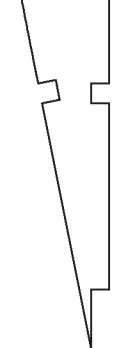
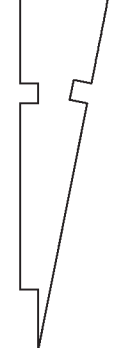
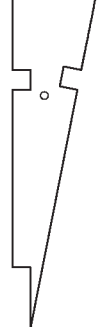
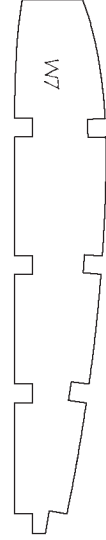
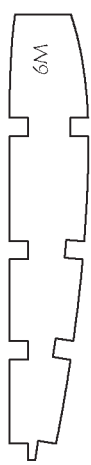

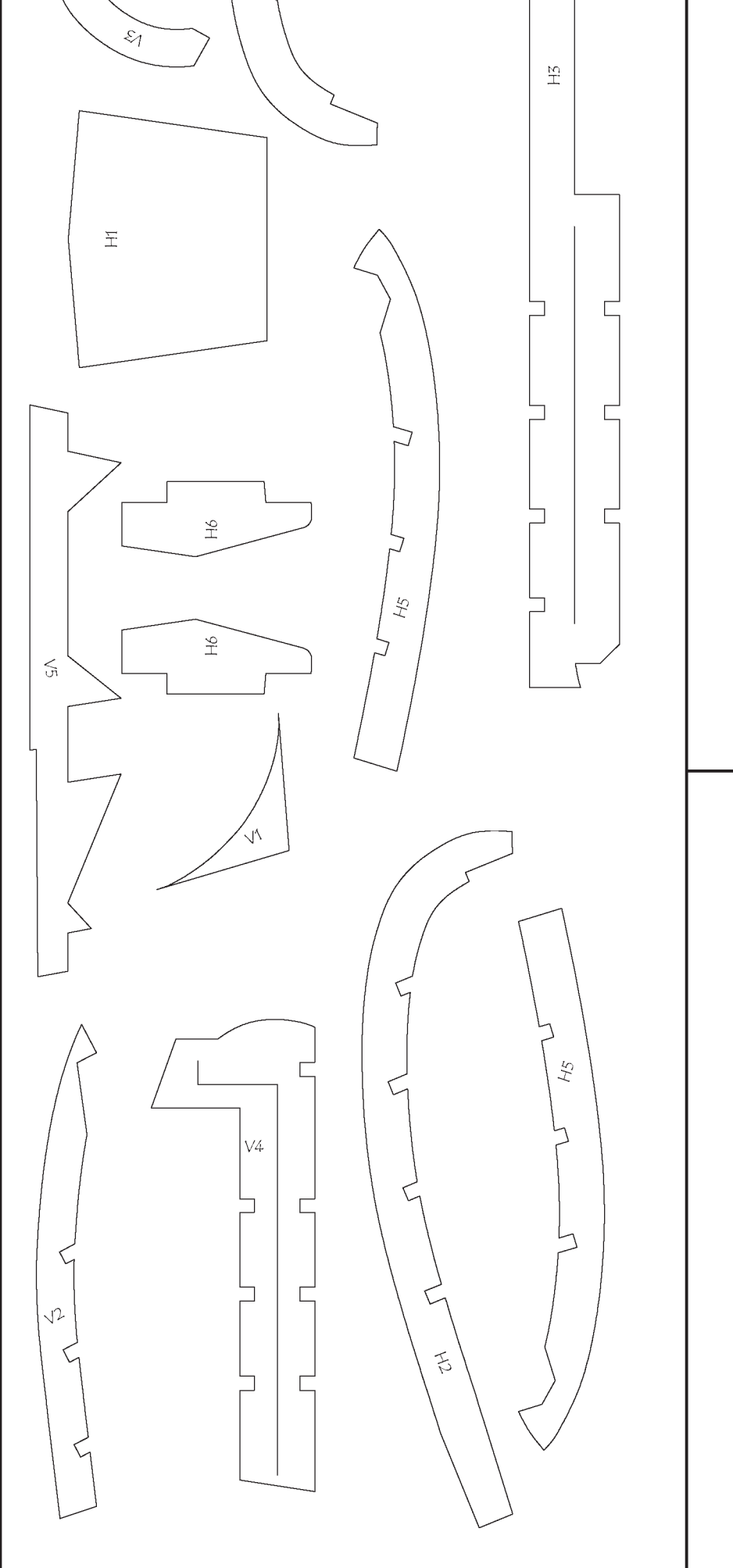
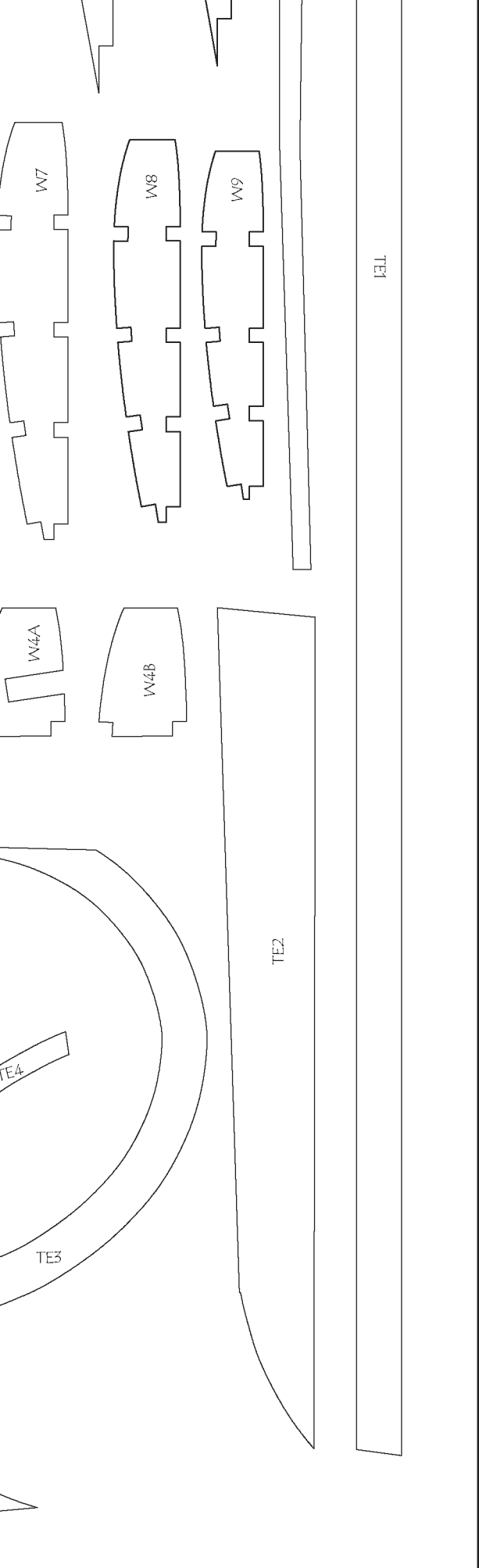



SECTION

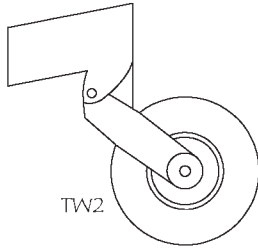
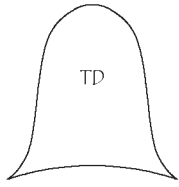
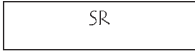
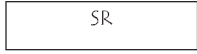
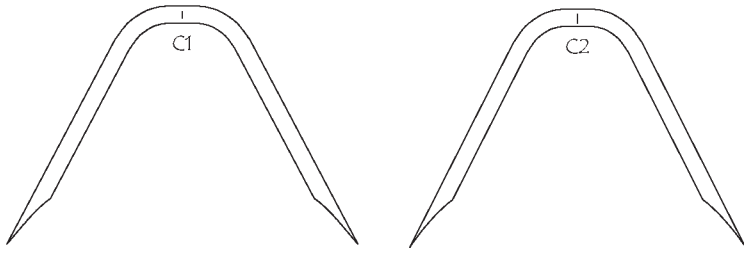

TEMPLATES



LEADING
EDGE
TEMPLATES

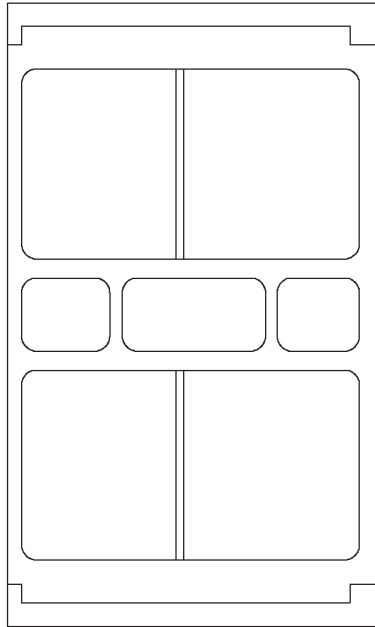
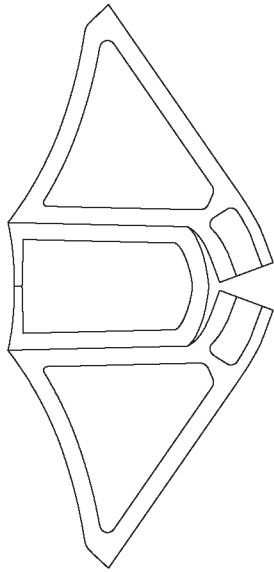

CANOPY TEMPLATES- MAKE FROM 3 MIL CLEAR PLASTIC

FOR THE AMOUNT
STATE LEADING EDGE

AIR INTAKE

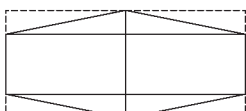

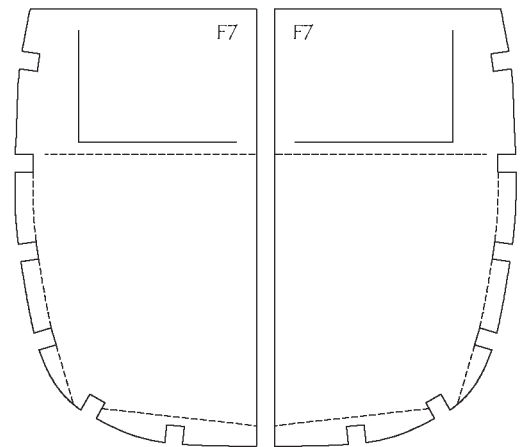
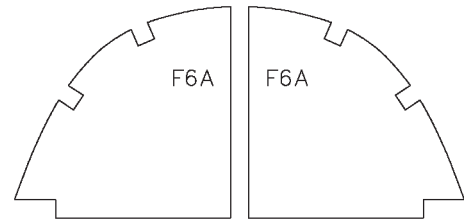
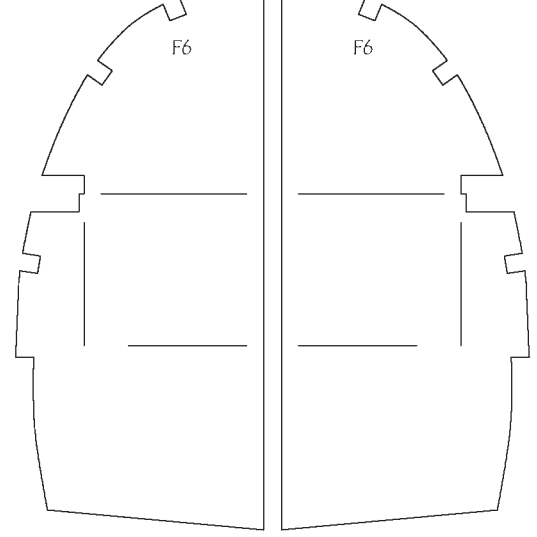

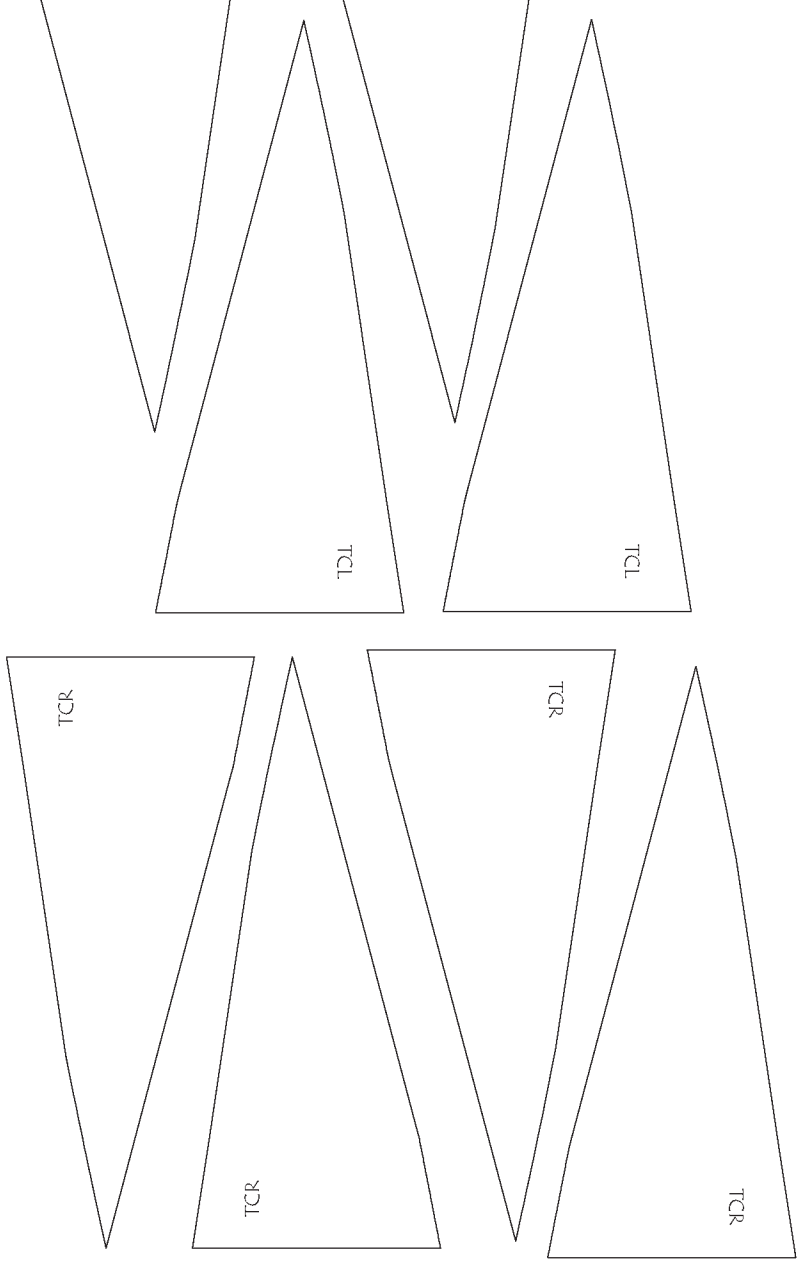
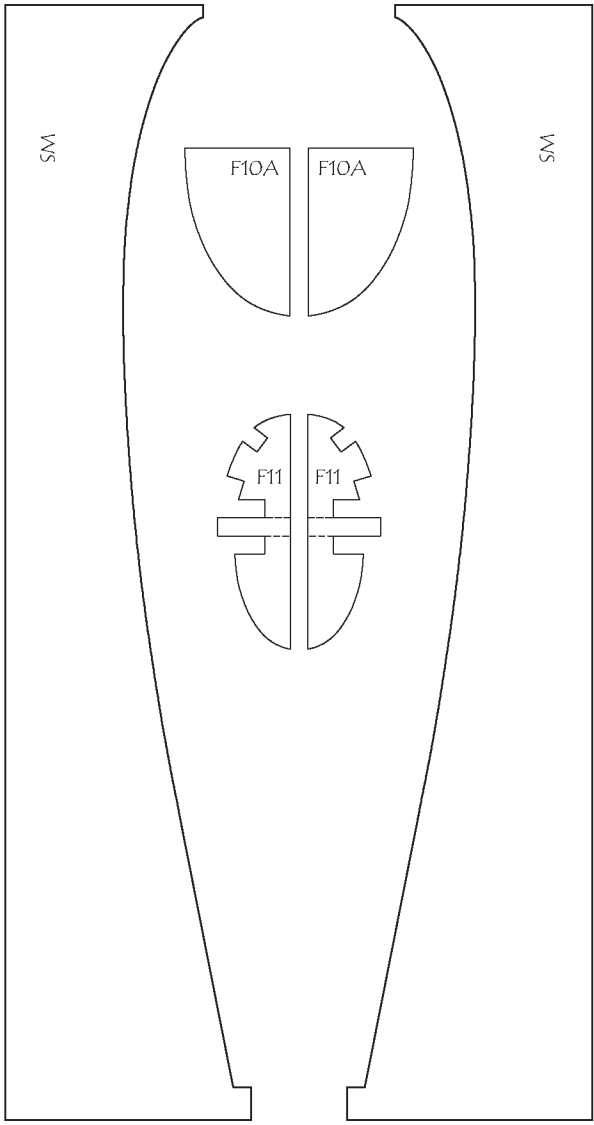

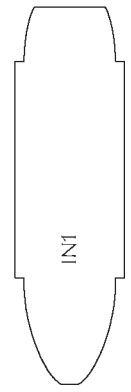
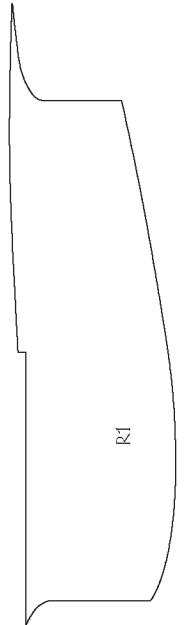
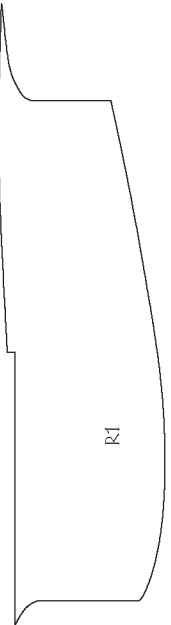
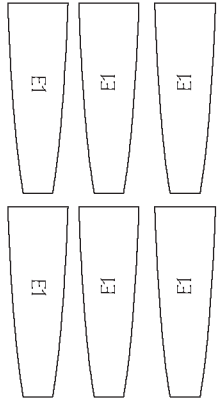
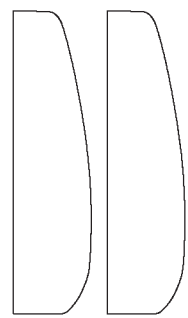
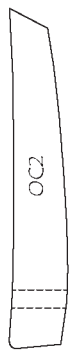
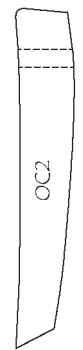
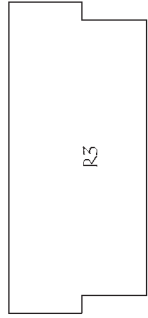
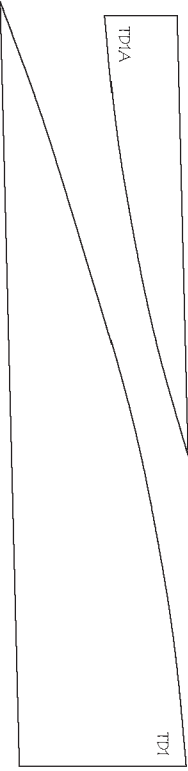
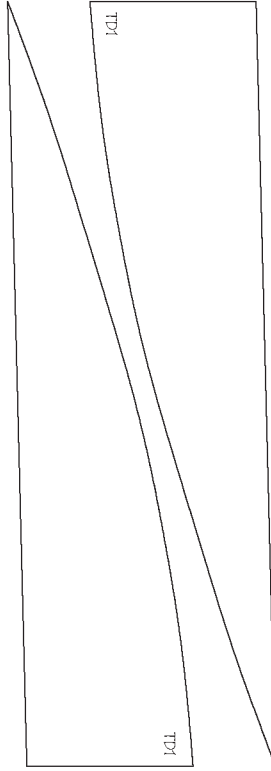
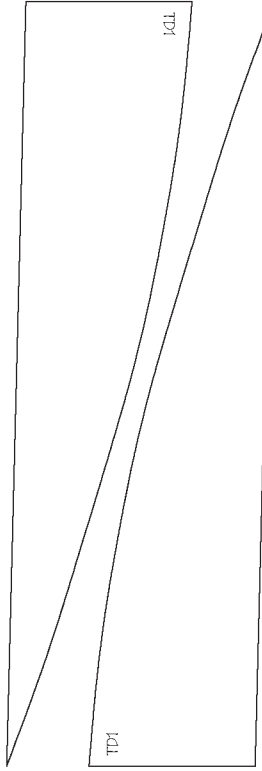
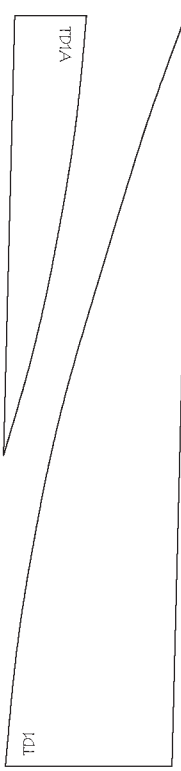

INT

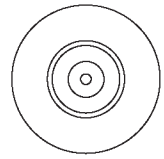
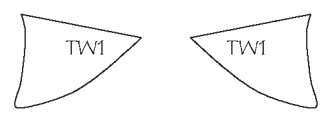
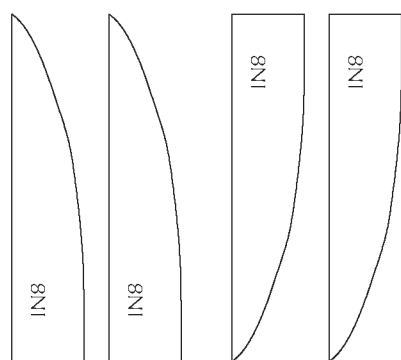
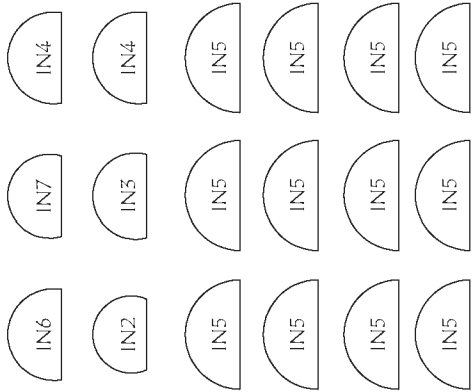

TW3

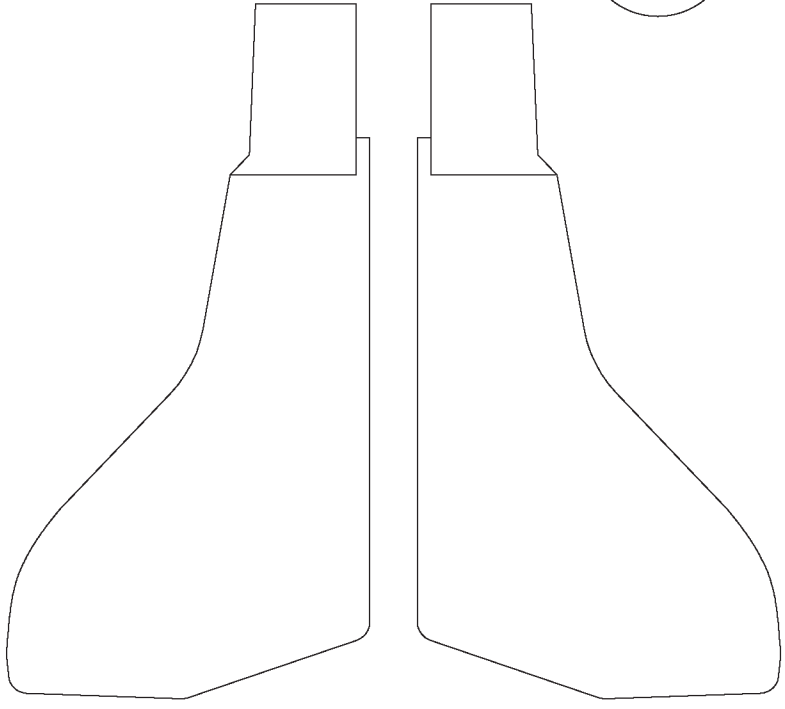
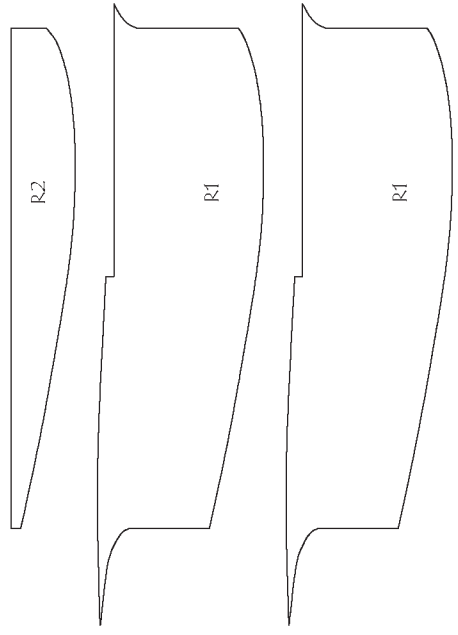

O



PRACTICE TEMPLATE- NOTE THE MARKINGS FOR THE AREA OF CURVE ADDED. FRONT DASHED LINES INDICATE LEAD

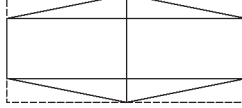

OUTSIDE | INSIDE

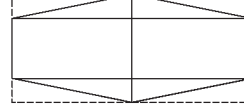

INSIDE | OUTSIDE

PLASTIC CLIP- MADE FROM SODA BOTTLE

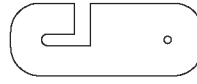

2 NEEDED

MACCHI 202 FOLGORE PARTS SHEET

DESIGNED BY DEREK MICKO-
30" WINGSPAN
6-9 OUNCES
CHANNELS: 4
MOTOR: 18-24 GRAM
ALL RIGHTS RESERVED

Sheet 2 of 2 Plan No. 1132

