

RI MIRRO

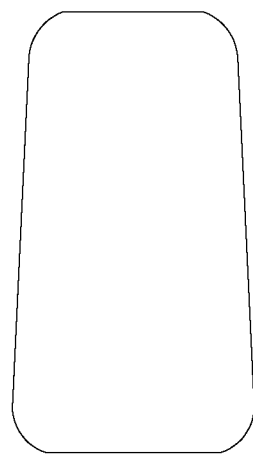
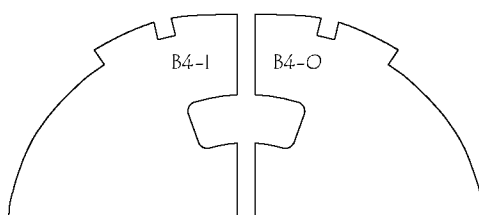
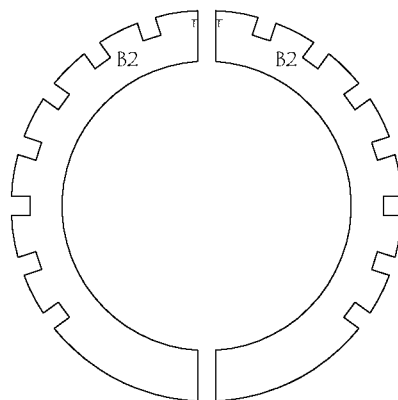
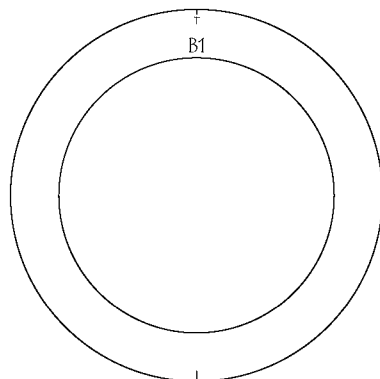

RIGHT BOOM

FOR LEFT BOOM PARTS

3/32" BALSA

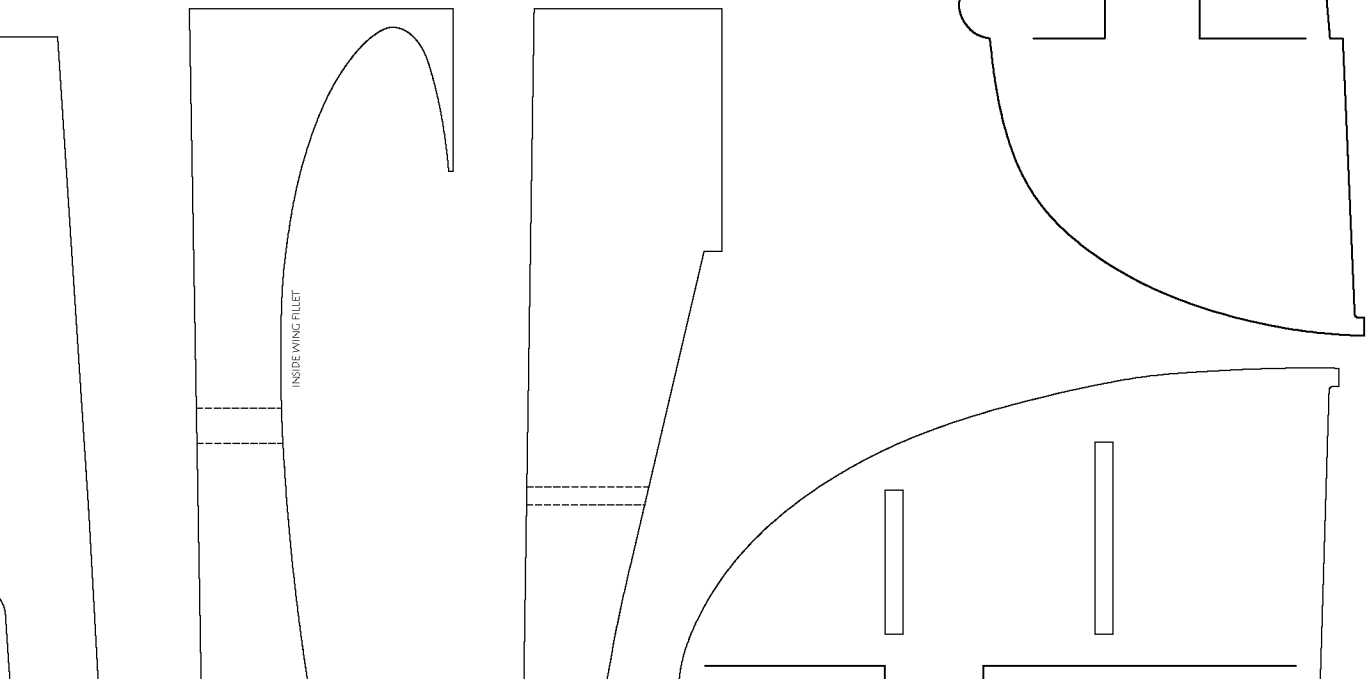

RIGHT WING PANEL

MIRROR FOR LEFT WING PARTS

3/32" BALSA

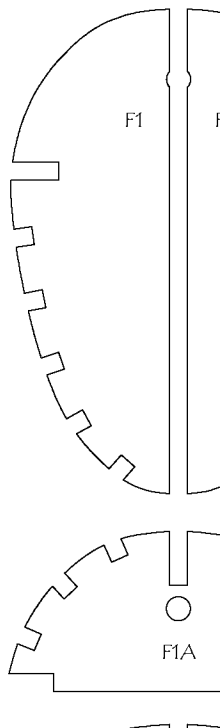
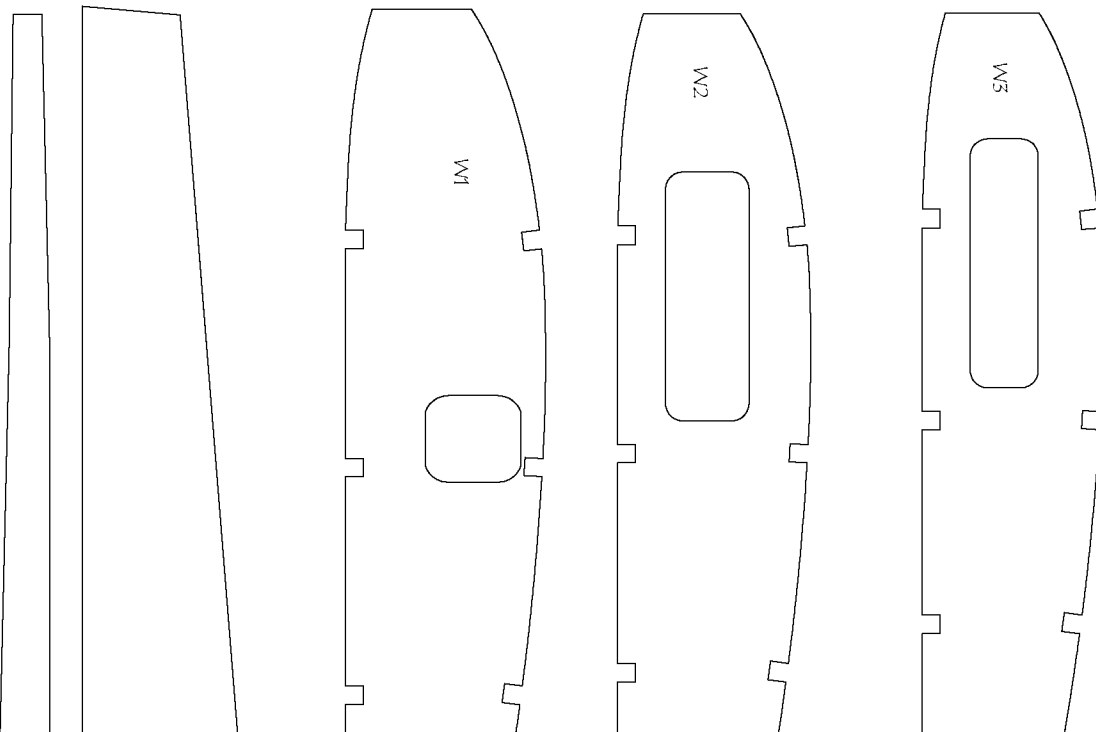

CENTER POD

3/32" BALSA

1/8" LITE PLY

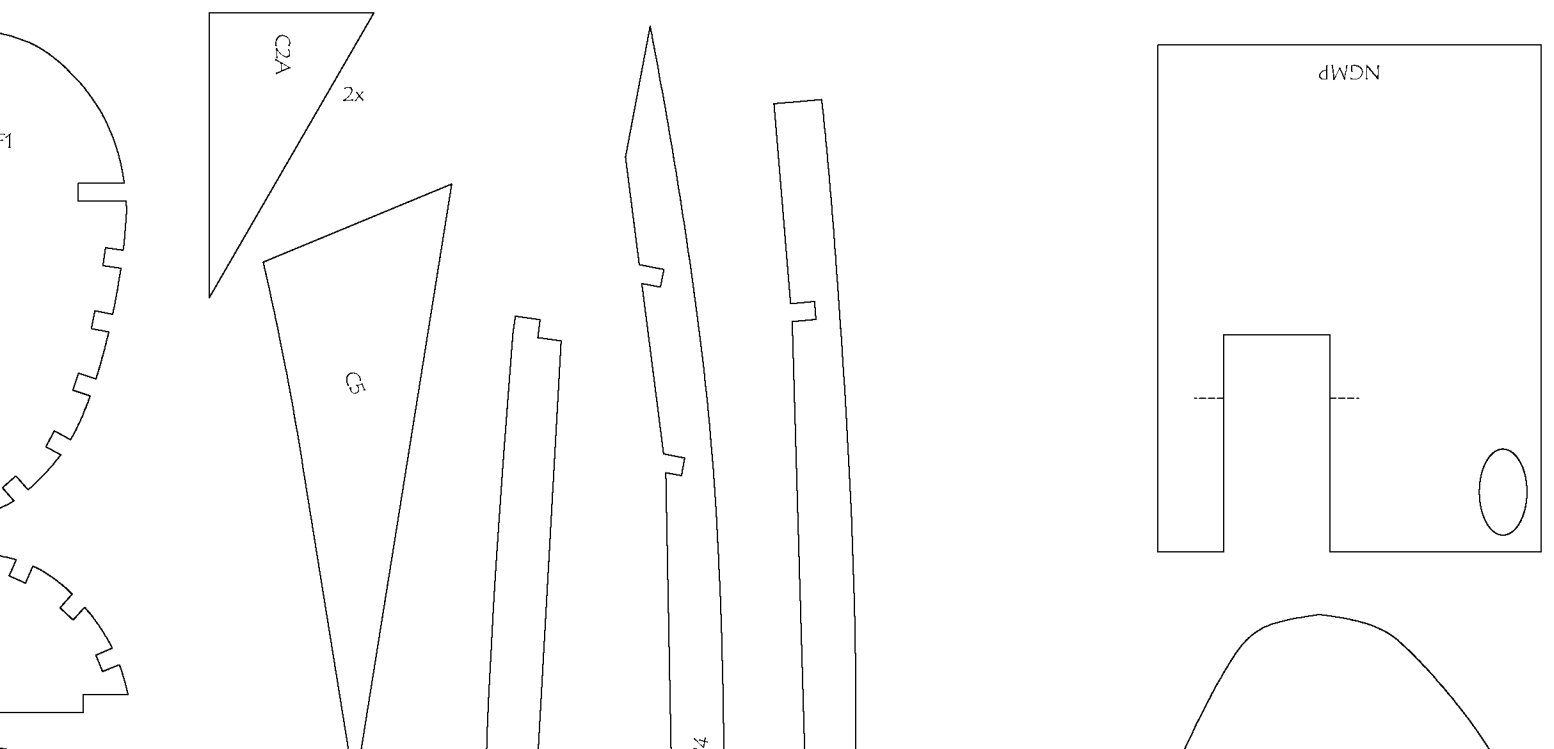

3/32" Balsa

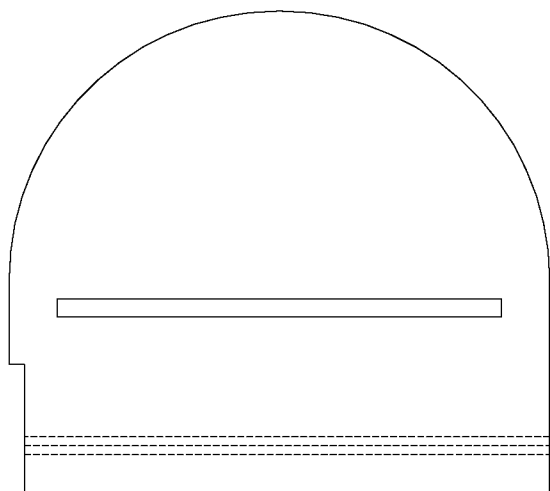

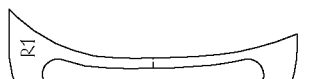
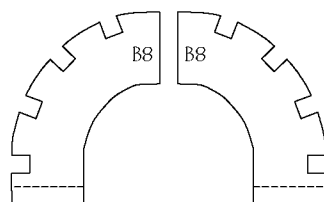
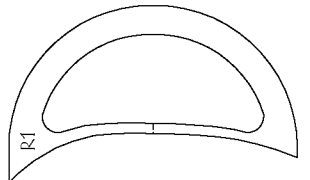
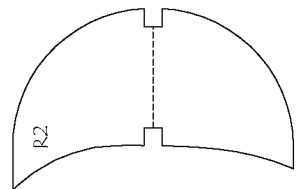
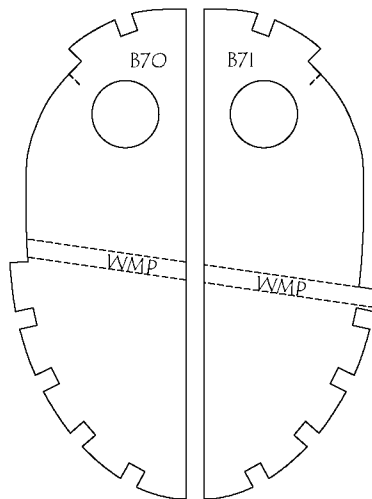
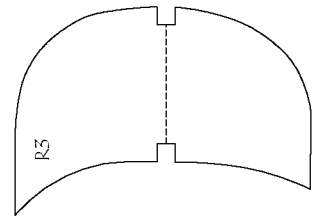
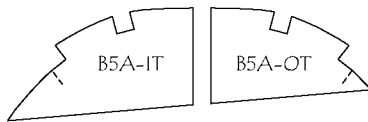
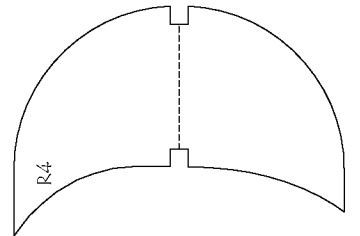
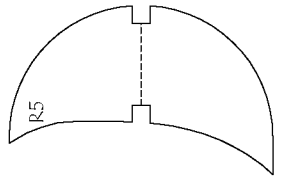
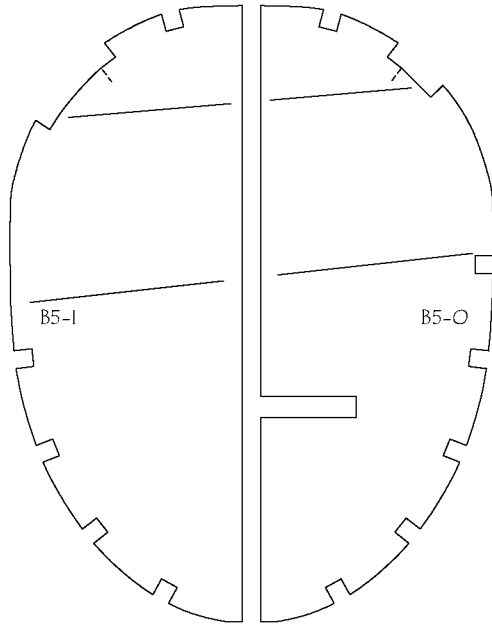
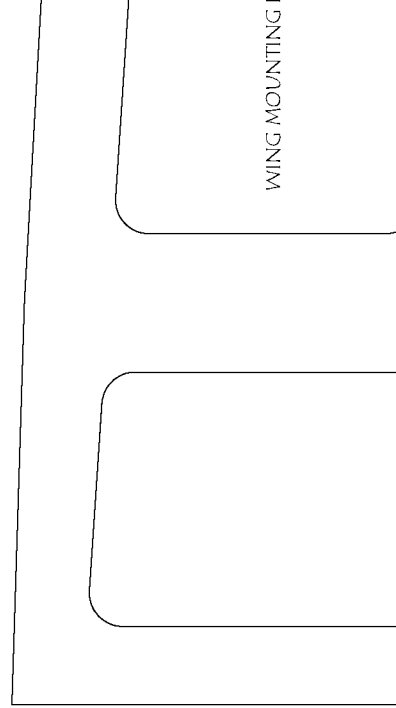
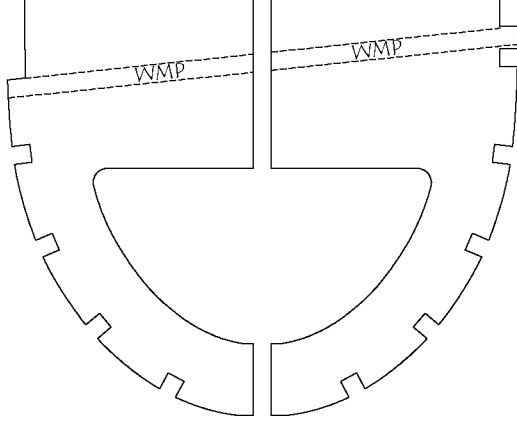

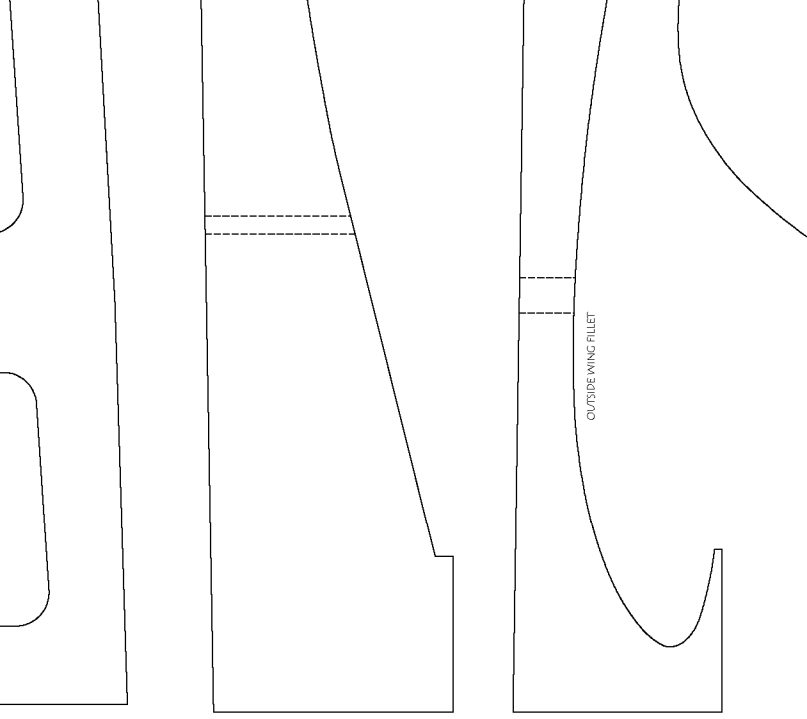

1/8" LITE PLY

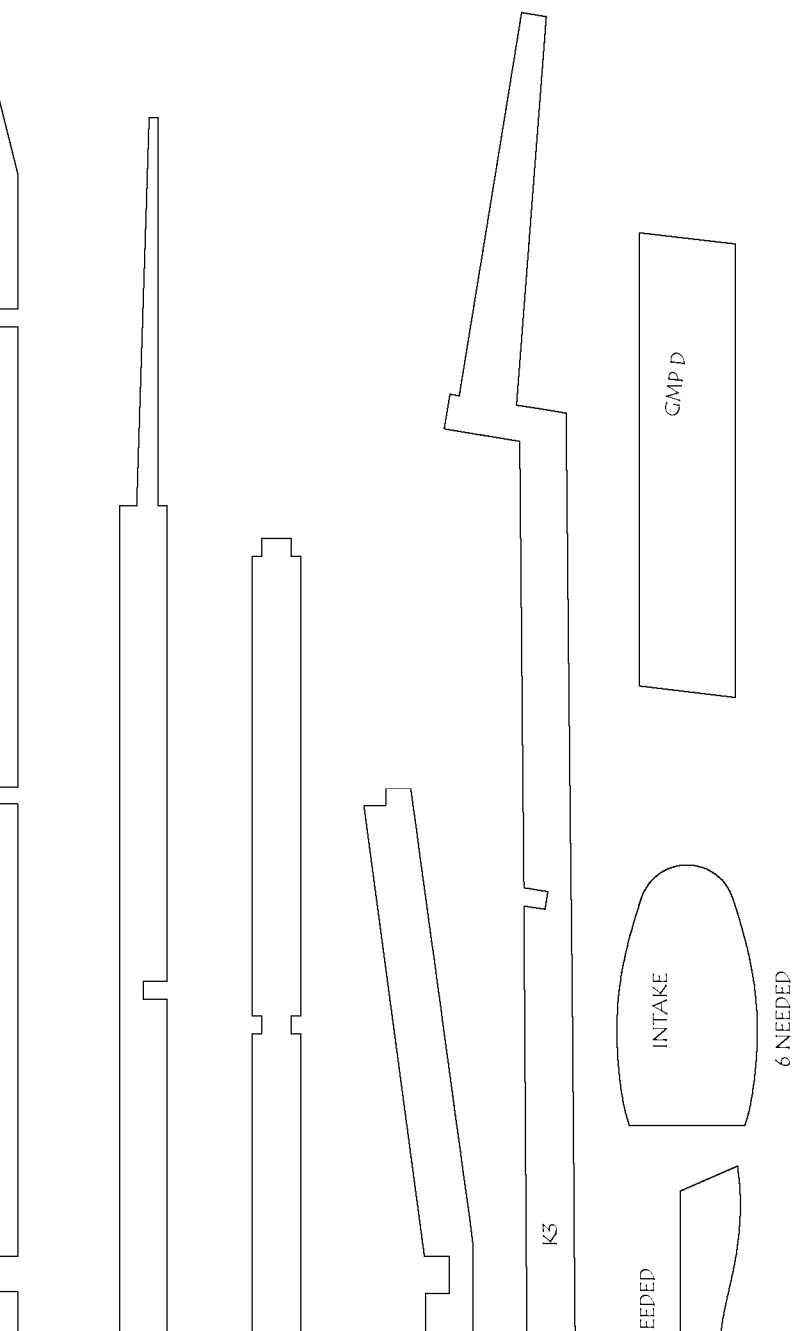
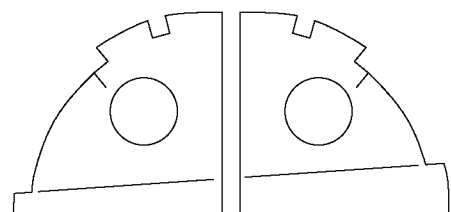
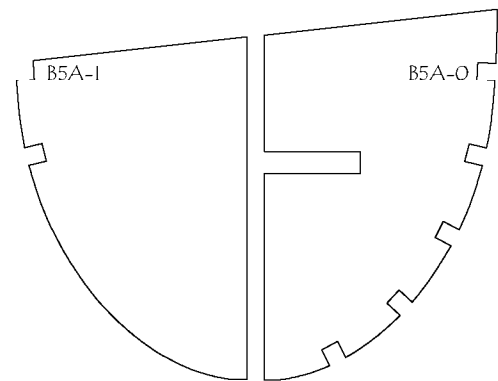
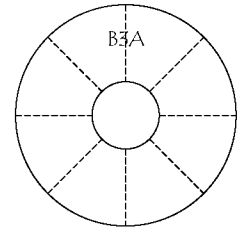
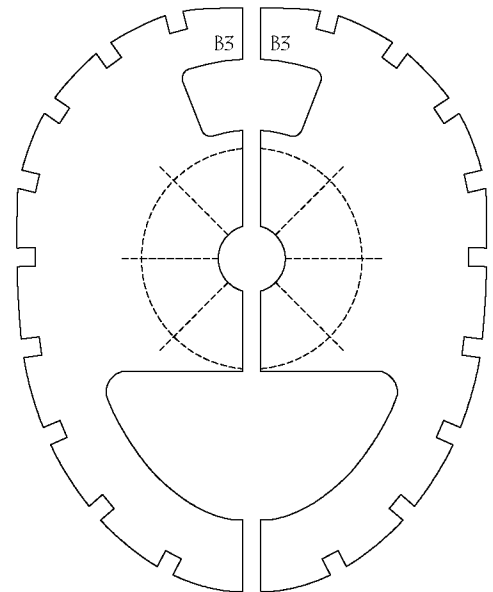

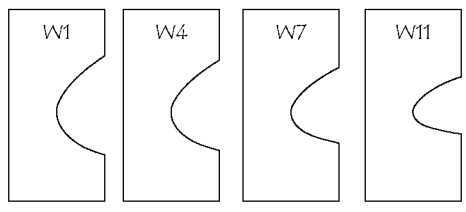
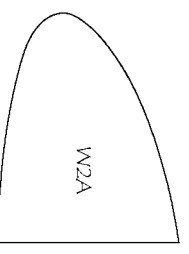
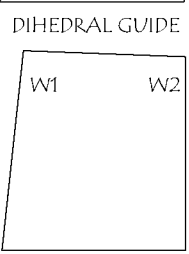
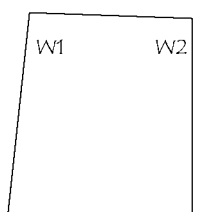
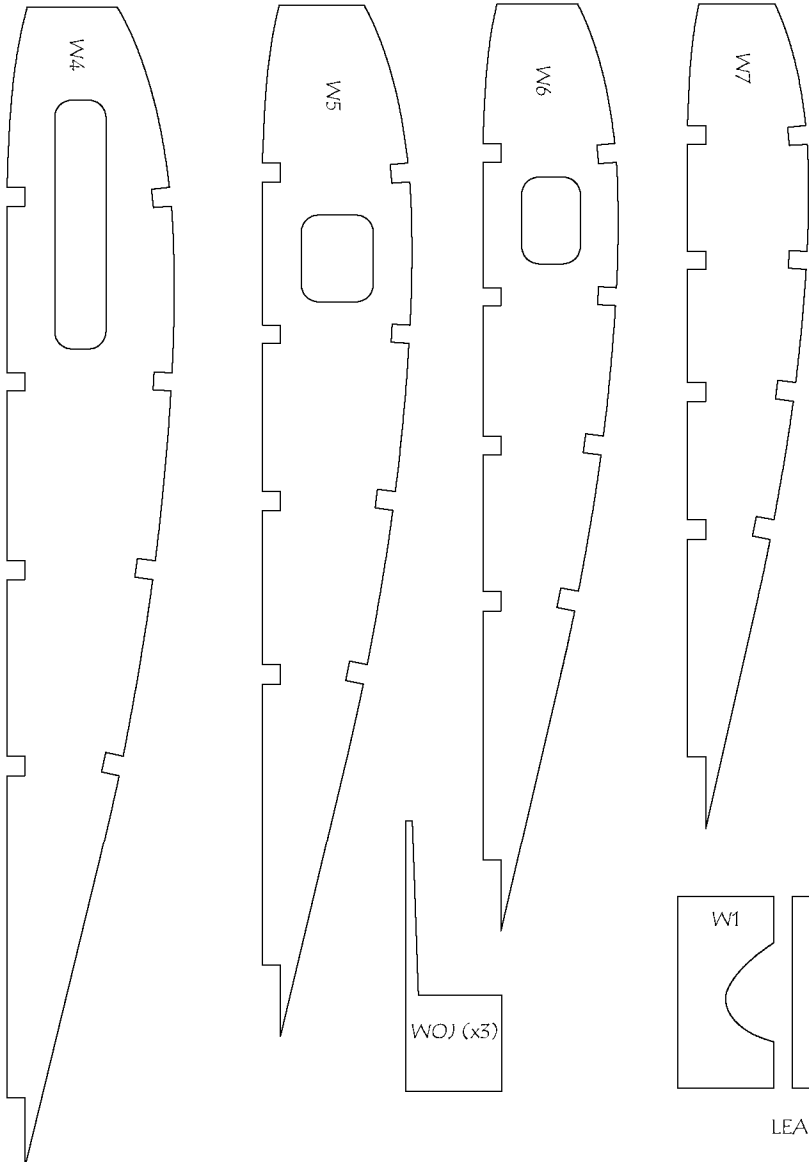
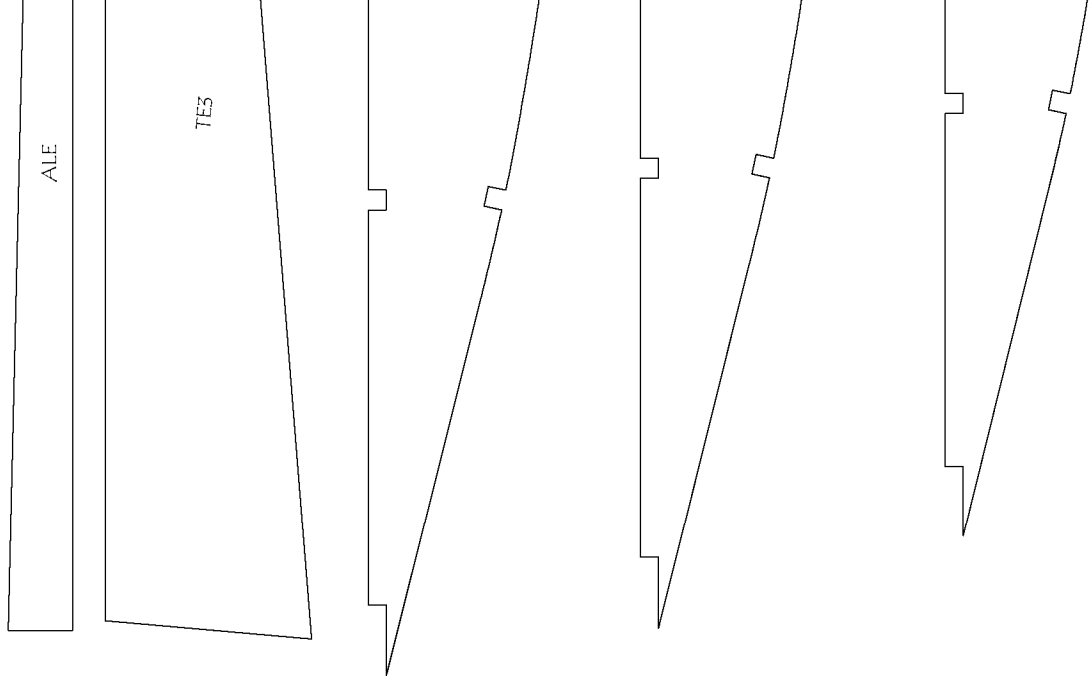

LEADING EDGE TEMPLATES

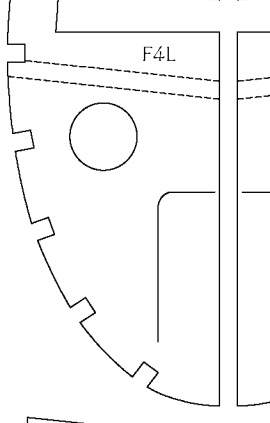
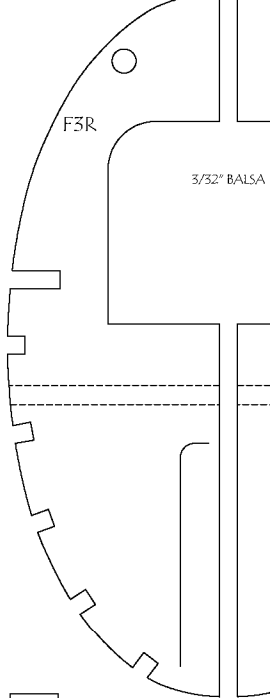
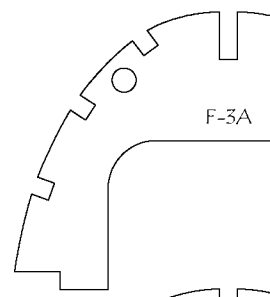
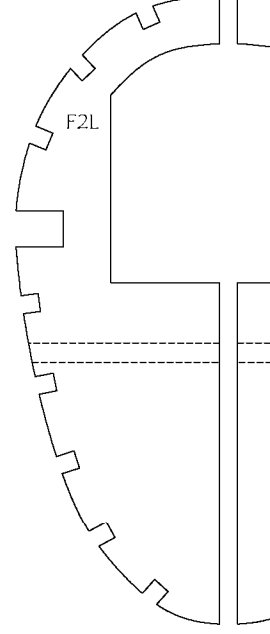

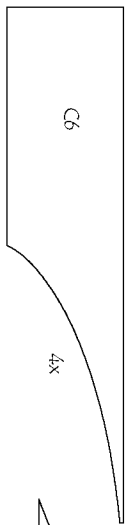
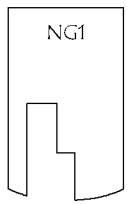
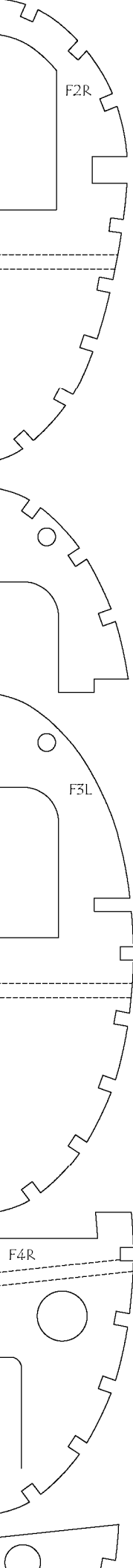

x4

P2

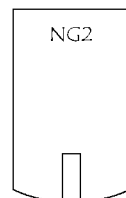
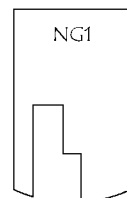
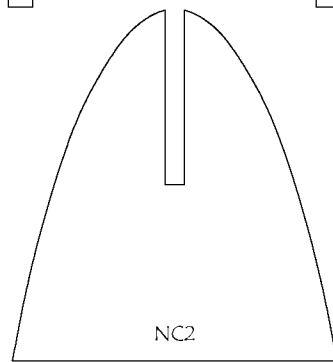
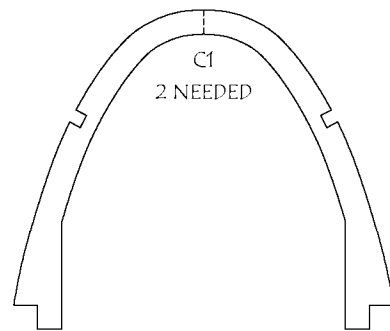
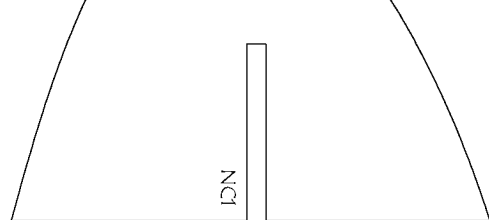
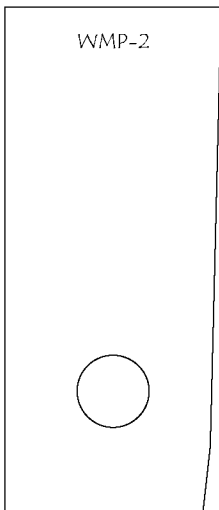
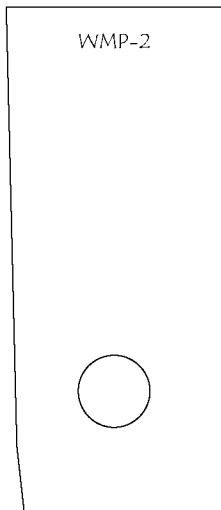
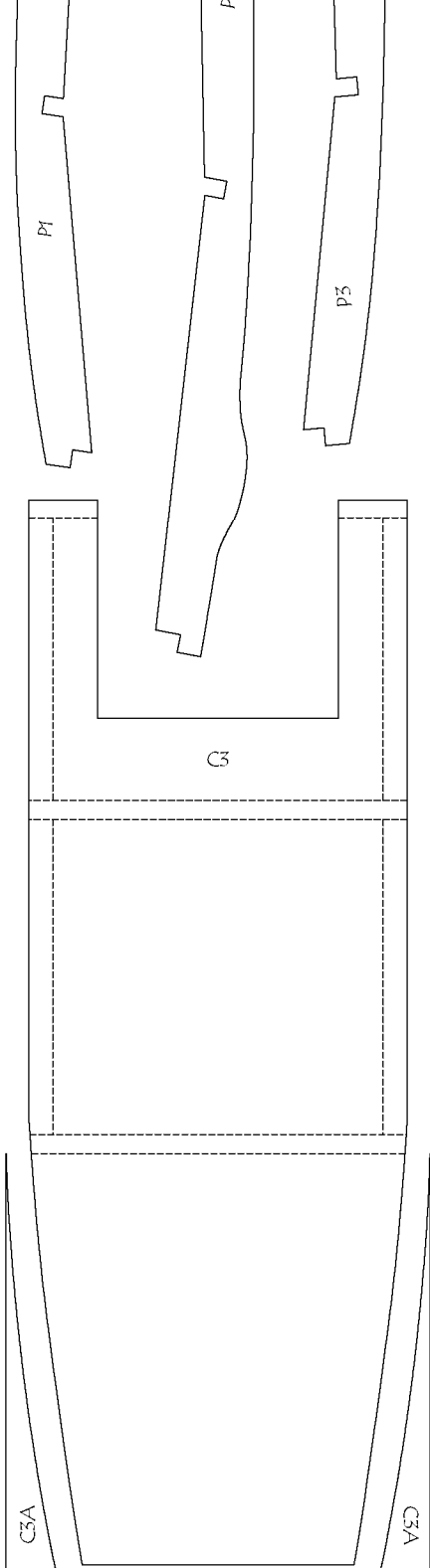

DIRECTION

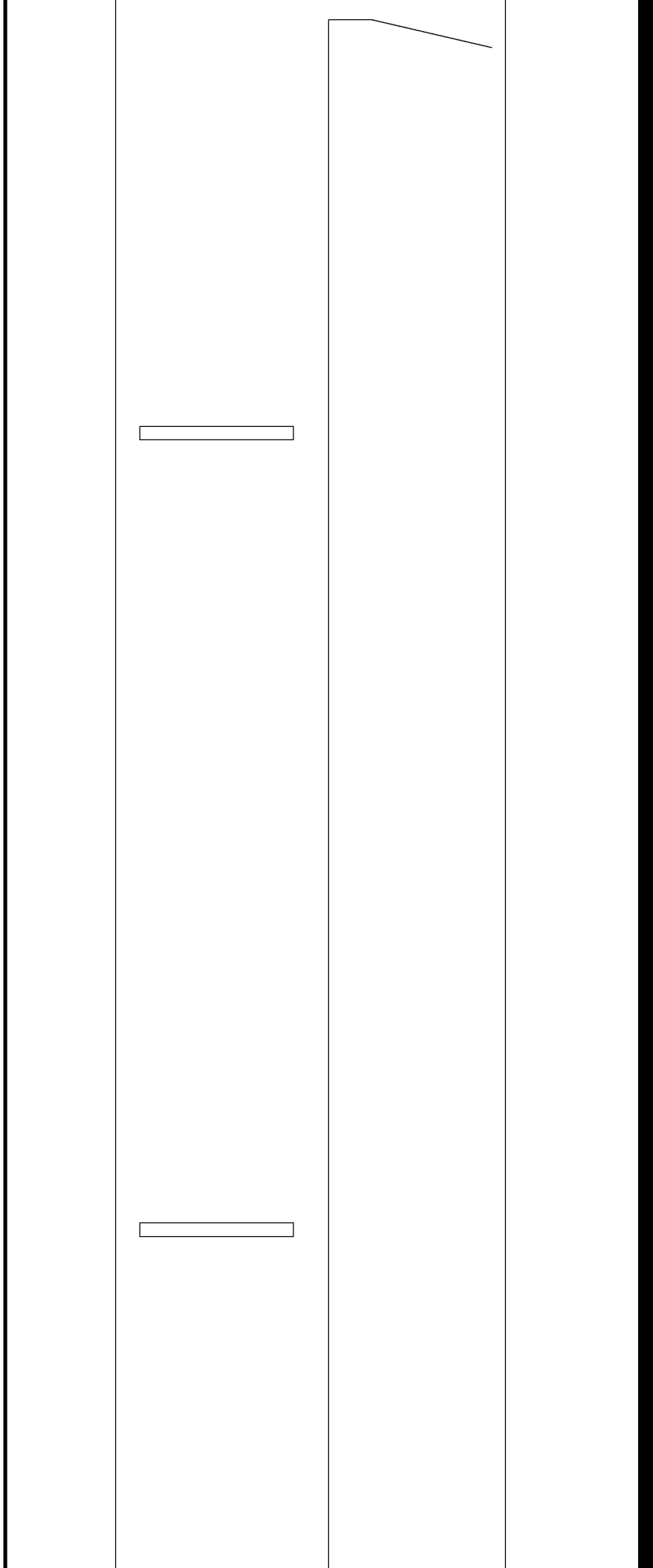

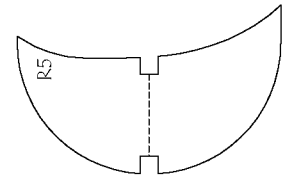
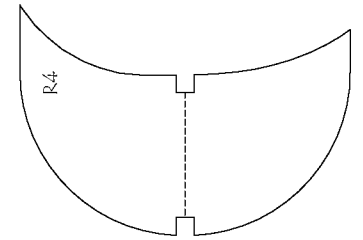
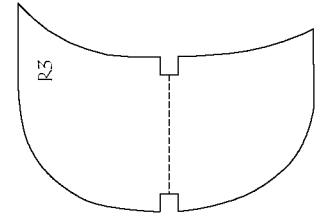
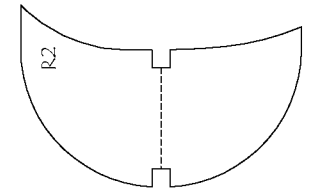
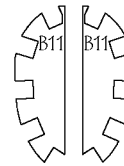
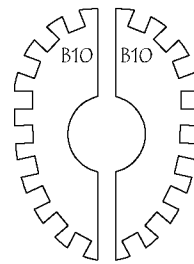
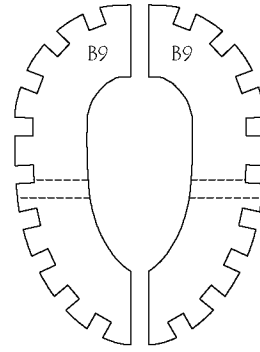
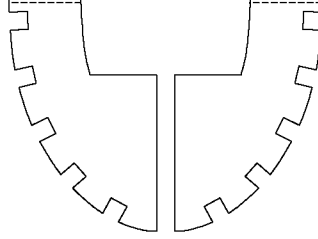

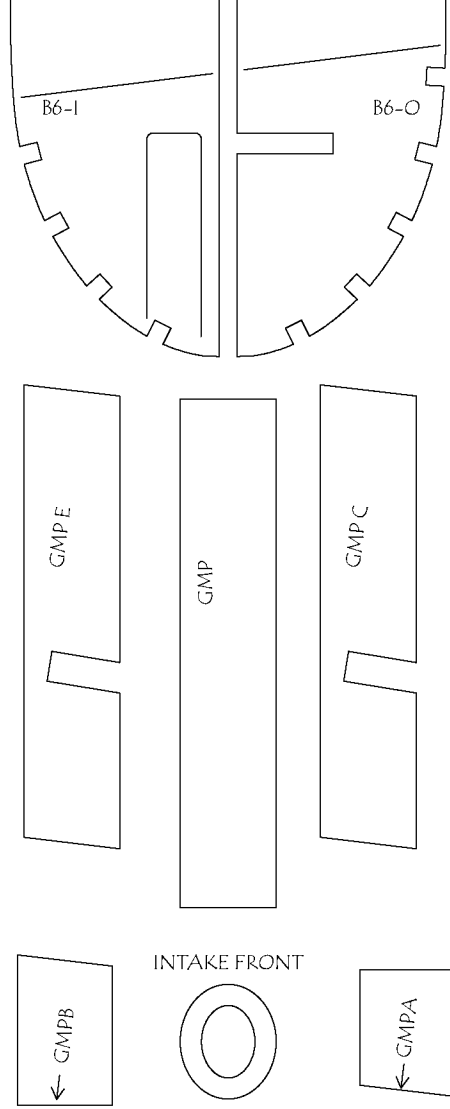
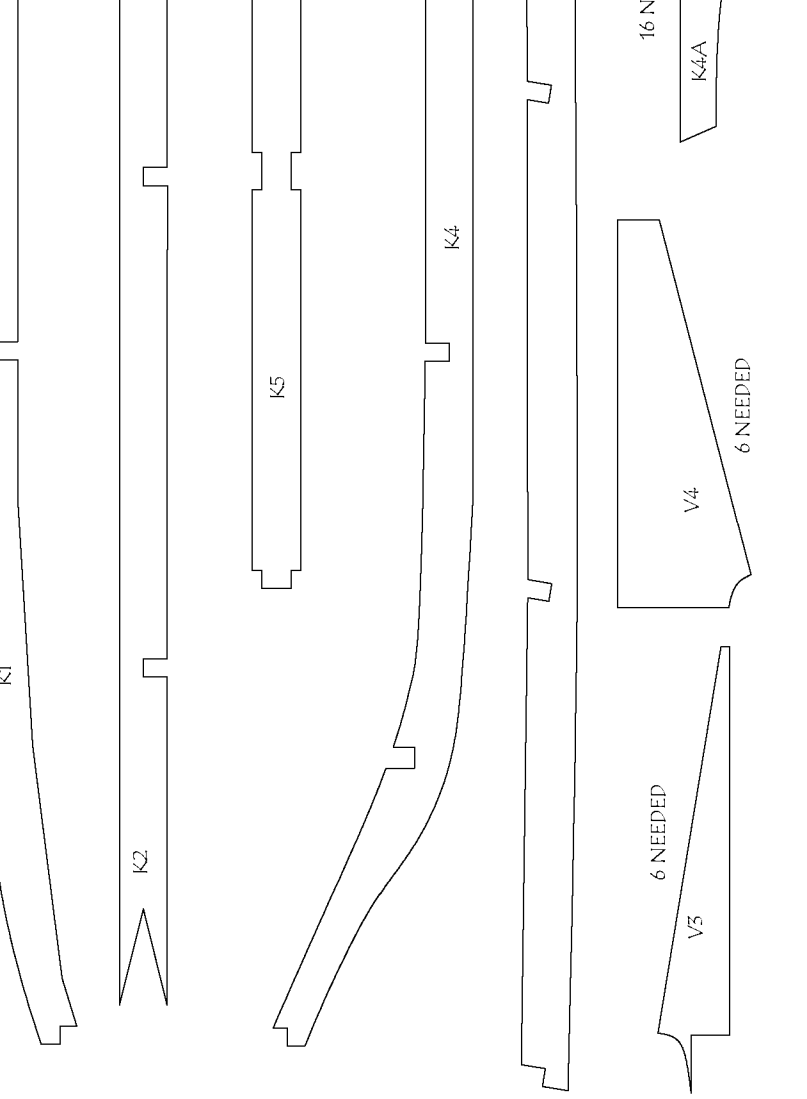

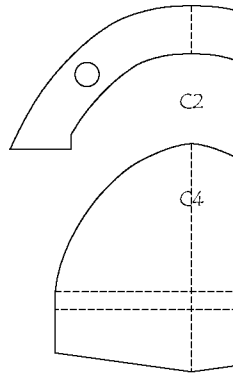
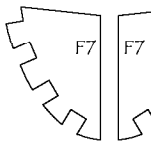
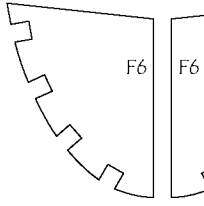
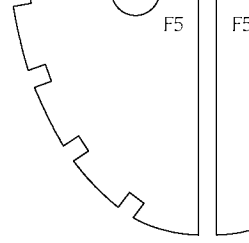
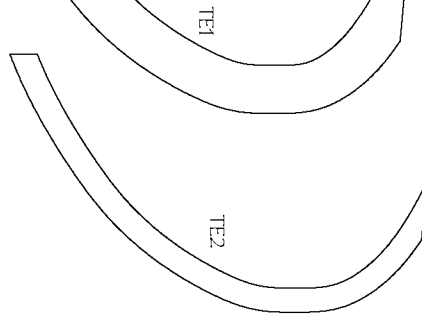
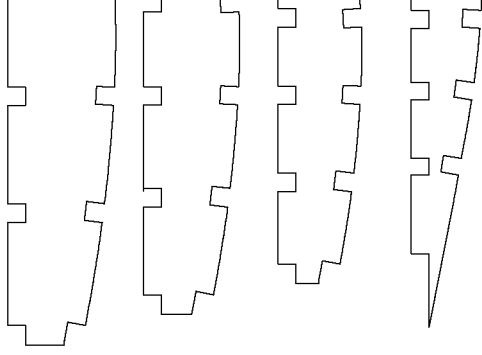

1/8" LITE PLY

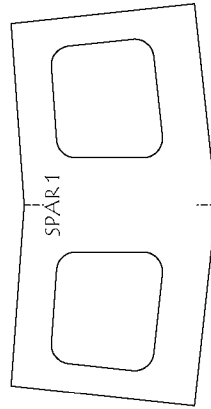

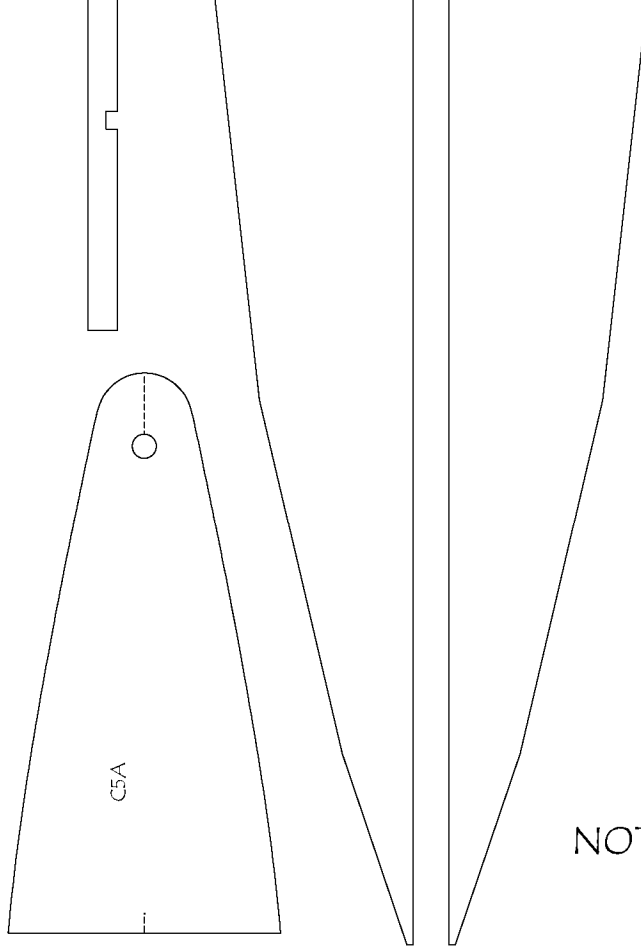
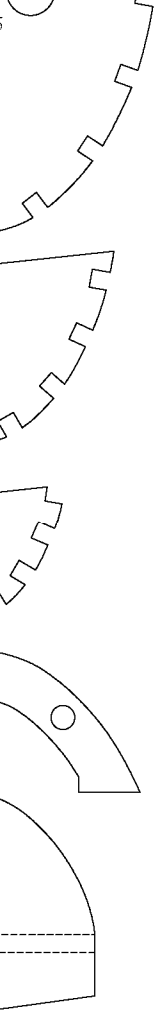

C5A

GRAIN

NOTE- DASHED LINES ARE REFERENCE

Copyright 2023  and **ModelAviation**
Copying for resale of this drawing without
the written approval or consent of AMA
is expressly prohibited.

SHEET 6

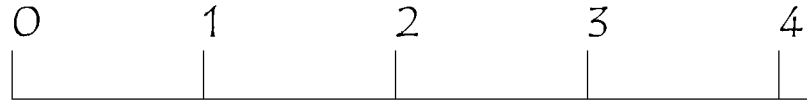

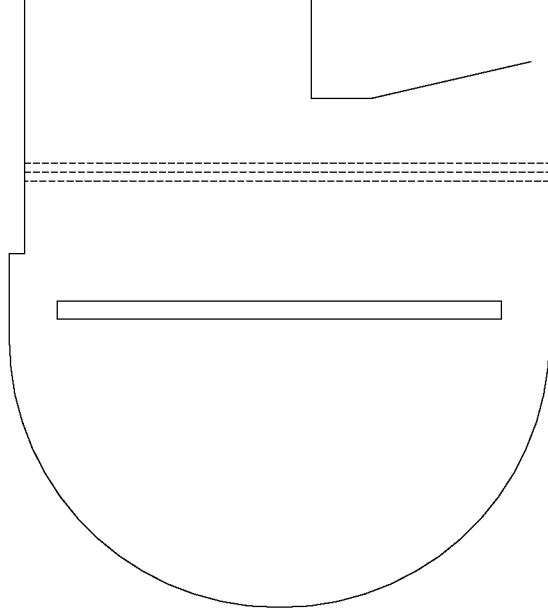

P-38 F LIGHTNING

PARTS SHEET

DESIGNED BY DEREK MICKO-

40" WINGSPAN

10-12 OUNCES

CHANNELS: 5

MOTOR: 18-24 GRAM x2

ALL RIGHTS RESERVED

Plans No. 1138

ARCH D 24" x 36"

5

6