

1/4-inch x 1/4-inch  
Basswood Spar

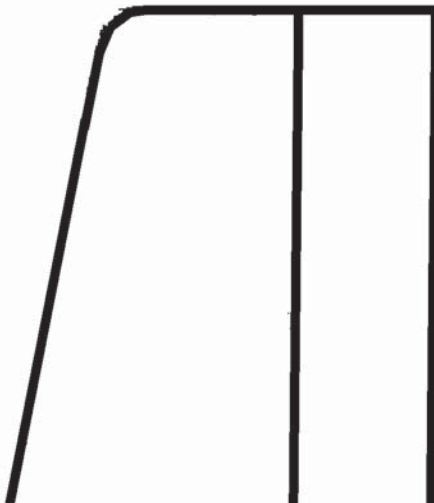

Fuselage, Ailerons, and Tail  
Surfaces Made of 5mm or 1/4 inch:

- Balsa Products Foam
- Or – Insulation Foam
- Or – Depron
- Or – Midwest CellFoam 88

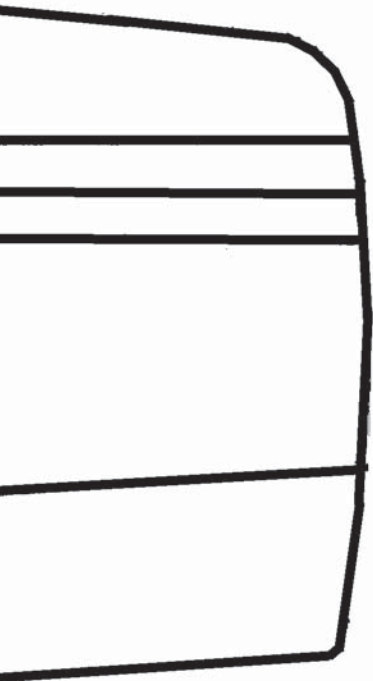

1/32-inch

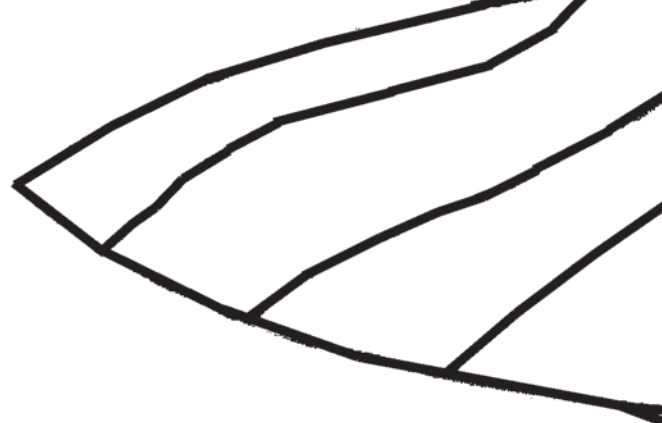

**1/32-inch Plywood Doublers**

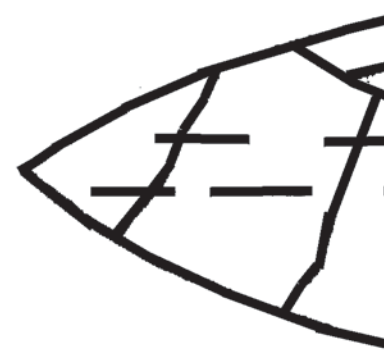

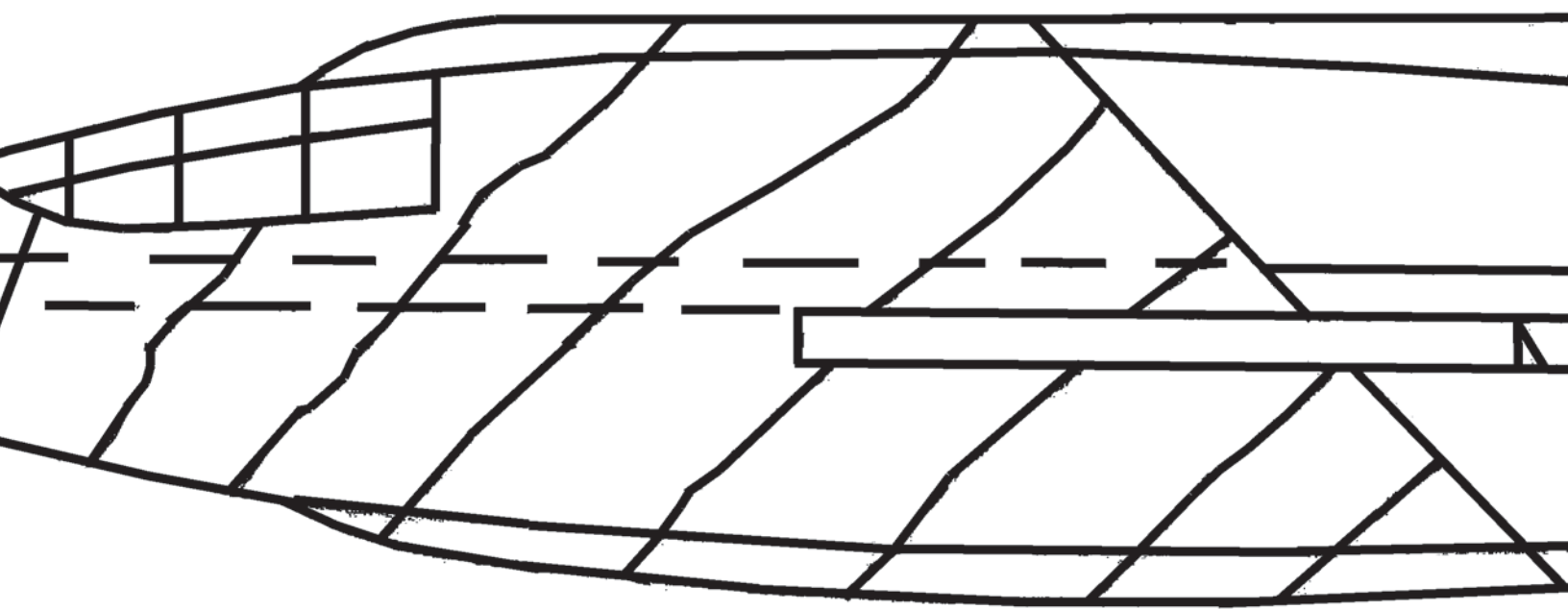
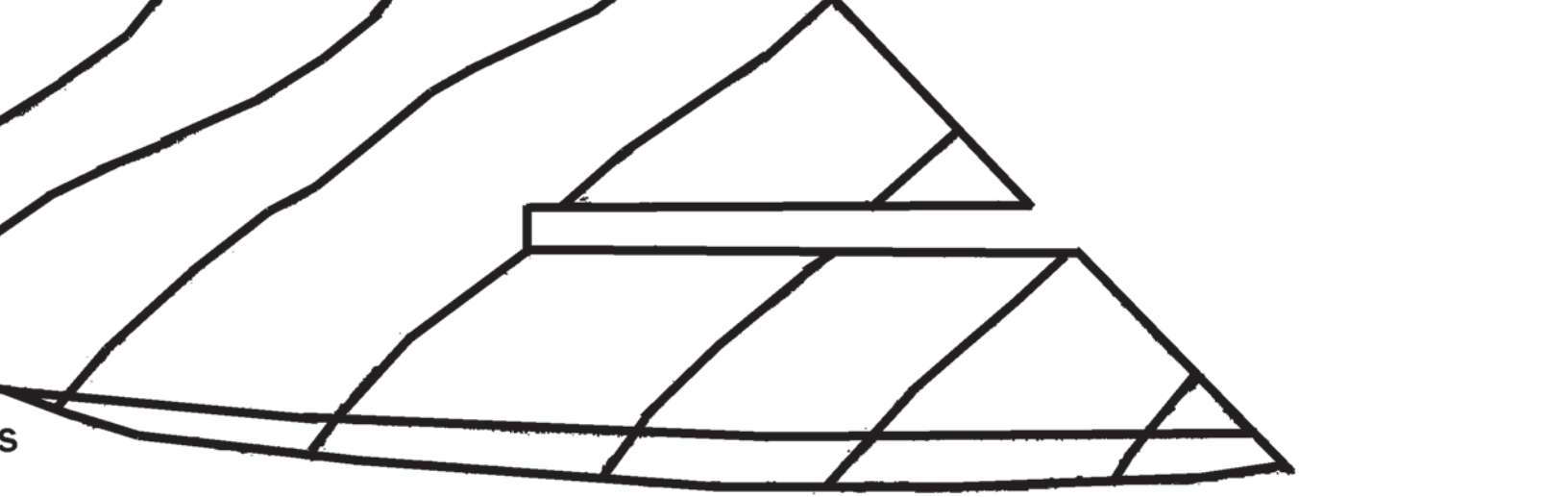

Approximate  
Balance Point



1/16-inch Plywood  
Control Horns

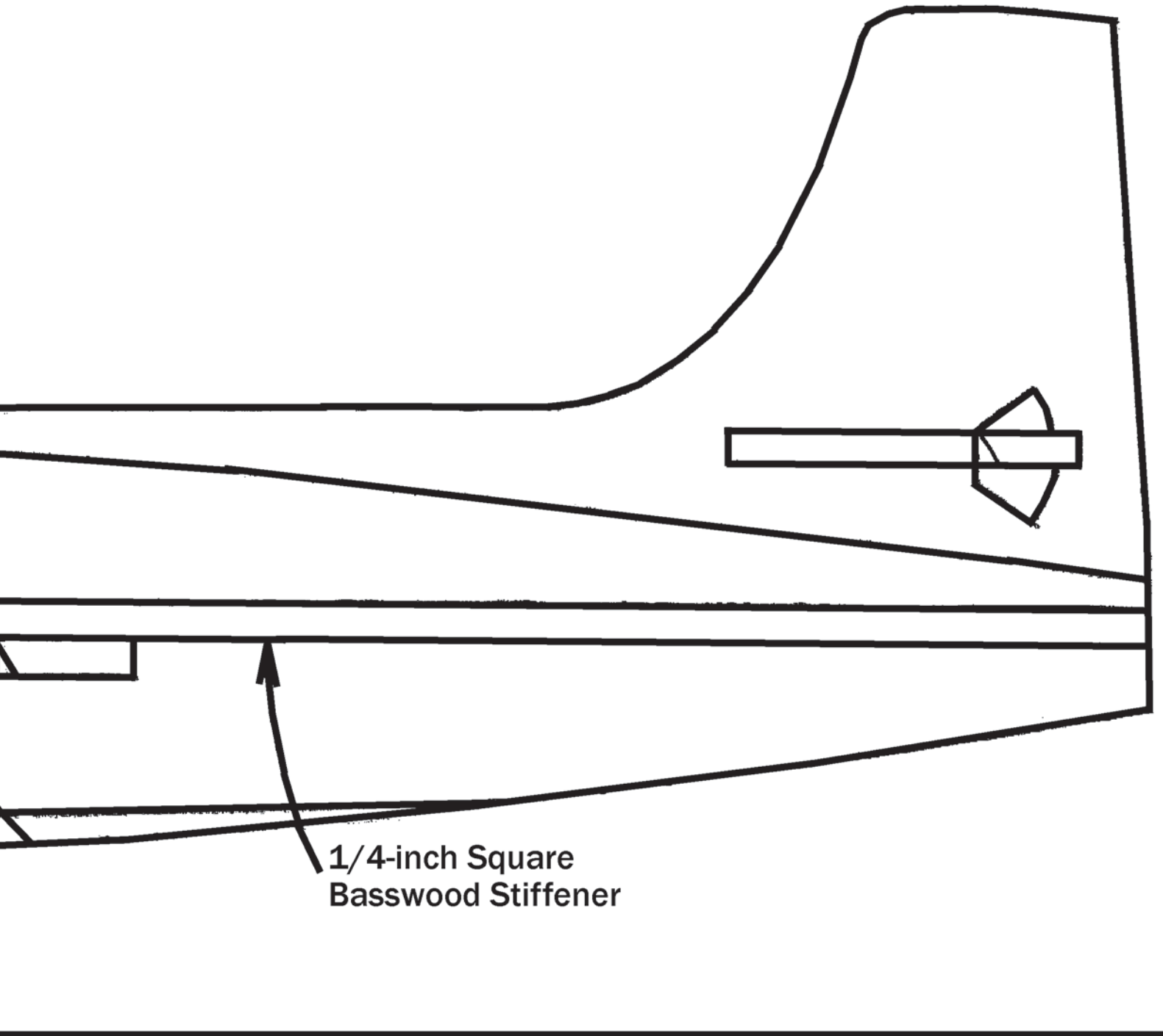

1/4-inch Square  
Basswood Stiffener

1/32-inch  
Plywood

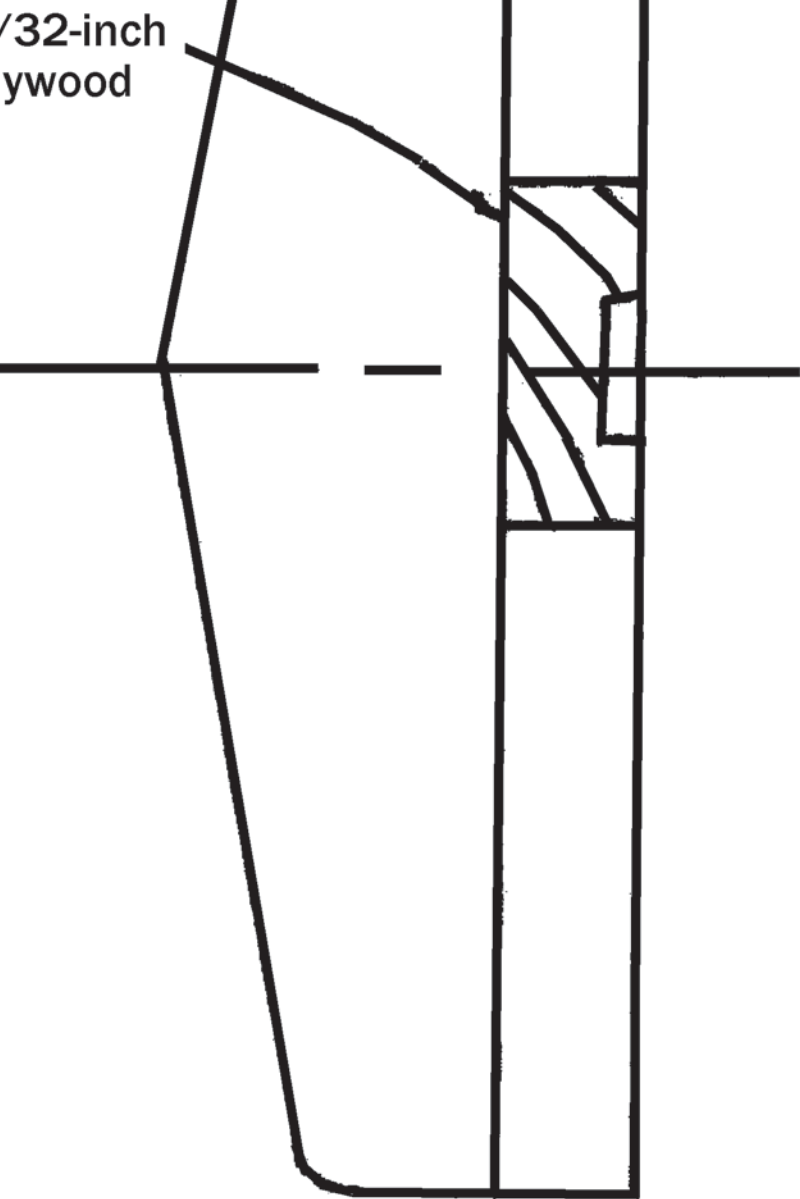

**Bell X-1**